



MOTOROLA



**SATELLITE
SERIES
9505
PORTABLE
TELEPHONE
USER'S GUIDE**













IRIDIUM

Options Menu Quick Reference





SATELLITE MODE HELPFUL HINTS

- Need clear view of sky, outdoors, away from buildings and tall structures. Rotate and fully extend antenna into a vertical position.
- Wait until registration is complete (you will see  Registered and the  and  indicators). If no registration ( missing), press  .
- To dial, press: [ ] or [ and hold for two seconds], [country code], [phone number], .
- Talk with antenna above your head and vertical to the ground.

Getting Started

1. Rotate and extend the antenna.



3. Insert the SIM card.

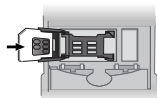

5. Remove battery's protective cover.



7. Attach battery door cover or optional Cellular Cassette.



2. Remove battery door.



4. Push down and slide the SIM card tray to the right.

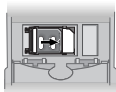

6. Install the battery by matching arrows on phone and battery.



8. Attach charging device.



9505 PORTABLE QUICK REFERENCE

Basic Operation

Turn the phone's power on/off:

Press and hold **[Power]**.

Place a call:

Rotate and extend the antenna in a vertical position. To dial, press: **[0+]** **[0]** **[0]** or **[0]** **[0]** and hold for two seconds, [country code], [phone number], **[OK]**.



Answer a call (with antenna rotated and extended):

Phone rings and/or vibrates

After Call followed by Answer? is in display, press **[OK]**.

Answer a call (with antenna stowed):

Phone chirps

Rotate and extend antenna

Phone will ring and/or vibrate

After Call followed by Answer? is in display, press **[OK]**.

End a call:

Press **[C]**.

Special Features

Adjust earpiece volume:

Press upper and lower volume keys on the side of the phone.

Adjust ringer volume:

Press **[F]** and then the upper and lower volume keys on the side of the phone.

Clear the last digit in the display or exit a submenu:

Press **[C]**.

Clear the entire display or exit the menu system:

Press and hold **[C]**.

Select prompt language:

Press and hold **[V]** to return to idle display.

Press **[Menu]** **[2]** **[Menu]** **[6]** **[Menu]** **[OK]** to go to the language selection submenu.

Press **[Menu]** until you see the preferred language.

Press **[OK]** to select.

Special Features Continued

Keypad disable:

Press **[*]** and **[#]** keys simultaneously to prevent accidental usage of the phone. All keys with the exception of the **[C]** key will be disabled. You can still answer an incoming call by pressing **[OK]** when the keypad is locked. To remove the keypad disable, press **[*]** and **[#]** simultaneously.

Display your phone number:

Press **[Menu]** **[*]**.

Also refer to the "View Your SIM Card Phone Number(s)" section of the User's Guide.

Switch modes:

1. Press **[Menu]** until you see Mode Selection, and then press **[OK]**.
2. Press **[Menu]** to scroll to Cellular Preferred, Satellite Preferred, Cellular Always or Satellite Always.
3. Press **[OK]** to select.

Quick Access Menu

Factory default for satellite and cellular mode.

[Up]

[1] Find Name

[2] Mute

[3] Call Voicemail

[4] Battery Meter

[5] Lock Now

[6] Vibrate On/Off

[7] Read Messages

[8] Register Now

[9] Forward On/Off

Phone Book

Recall a number from the phone book:

1. Press **[Menu]**.
2. Enter the one-, two-, or three-digit location number of the entry, and then press **[OK]**.
3. Press **[OK]** to call the displayed entry.

Recall last ten numbers dialed:

1. Press **[Menu]** until you see Phone Book, and then press **[OK]**.
2. Press **[Menu]** to scroll to Last Ten Calls, and then press **[OK]** to select.
3. Press **[Menu]** to scroll to Last Calls Made and then press **[OK]** to select.
4. Press **[Menu]** to scroll to the number you are looking for.
5. Press **[OK]** to place a call to that number.

Welcome

The future of global telecommunications is here—a satellite telephone, providing you with communication in many remote areas around the world.

Motorola proudly introduces its next generation Satellite Series™ 9505 portable phone for the Iridium® satellite system.

All Motorola wireless phones are designed and manufactured to meet Motorola's exacting specifications and world-class quality standards. During development, our laboratory testing team performed rigorous durability tests including temperature, humidity, shock, dust, vibration, and drop tests—and it still worked! We are confident that the phone you purchased meets your own exacting standards.

Thank you for choosing Motorola, a global leader in communications technology.

Enjoy your new Satellite Series™ 9505 portable phone!

Contents

Safety Information	7
Overview	11
Guide Overview	12
Phone Overview	13
Indicators	16
Satellite Series™ Accessories	19
Getting Started	25
Attaching the Satellite Antenna	26
What Is a SIM Card?	27
Installing/Removing the SIM Card	28
Removing the Battery Cover	30
Installing the Battery	31
Charging the Battery	35
Checking Battery Charge Level	37
Battery Information	38
Installing the Cellular Cassette	39
Using Your Phone	41
Startup Procedures	42
Placing a Call	46
Receiving a Call	51
Additional Phone Features	54
Using In-Call Features	57
Muting a Call	58
Using Call Waiting	59
Placing a Call on Hold	61
Making a Conference Call	63
Sending a Phone Flash	66
Using the Menus	67
Using the Options Menu	68
Using the Quick Access Menu	70
Using the In-Call Menu	72
Managing the Phone Book	75
Phone Book Menu	76
Organizing Your Phone Book	78
Storing Names and Numbers	80

Entering Names	82
Using Pauses in Numbers	84
Using Phone Number Prefixes	86
Locating Entries	87
Calling, Modifying, or Erasing an Entry	89
Checking Phone Book Capacity.	90
Preventing Access to the Phone Book.	91
Restricting Phone Use	92
Viewing the Last Ten Calls Made or Received	97
Viewing and Modifying Your Phone Numbers	99
Using One-Touch Dialing	101
Viewing Service Phone Numbers	103
Using Calling Features	105
Call Related Features Menu	106
Forwarding Calls When Unavailable	108
Forwarding All Your Calls	110
Using Detailed Call Forwarding	112
Canceling All Forwarding	115
Activating Call Waiting	116
Restricting Calls with Call Barring	117
Viewing the Battery Meter.	122
Viewing Signal Strength	123
Deactivating Pending Call Drop Signal	124
Restricting Your Phone Number ID.	125
Using Message Services	127
Messages Menu	128
Checking Your Voicemail	129
Managing Your Received Messages	130
Accessing Received Messages.	132
Managing Outgoing Messages	136
Managing Other Message Settings	144
Customizing Phone Features	149
Phone Setup Menu	150
Managing Phone Ringer Settings.	152
Locking and Unlocking Your Phone	154
Activating the Infrared Data Port	156
Protecting the SIM Card	157
Managing Other Security Settings	159

Activating Extended Menus	161
Managing Time and Date Settings	162
Selecting the Display Language	165
Turning Lights On and Off	166
Setting Keypad Tones	167
Managing Phone Settings	168
Cellular Mode Settings	171
Accessing the Network	177
Network Selection Menu	178
Registering With the Satellite Network	179
Cellular Mode Settings	180
Selecting a Mode	185
Mode Selection Menu	186
Phone Behavior by Mode	187
Selecting Satellite Mode	188
Selecting Cellular Mode	190
Timing Your Calls	191
Call Meters Menu	192
Showing Call Timers	193
Setting Audible Call Timers	195
Showing the In-Call Timer	197
Showing the Lifetime Timer	198
Customizing the Menu System	199
Personalizing the Options Menu	200
Personalizing the Quick Access Menu	202
Troubleshooting	203
Index	207
Patent Information	221

Safety Information

Important: Read this information before using your wireless mobile phone.

Exposure to Radio Frequency Signals

Your wireless mobile telephone is a low power radio transmitter and receiver. When it is ON, it receives and also sends out radio frequency (RF) signals.

International agencies have set standards and recommendations for the protection of public exposure to RF electromagnetic energy.

- International Commission on Non-Ionizing Radiation Protection (ICNIRP)1996
- Verband Deutscher Elektrotechniker (VDE) DIN-0848
- United States Federal Commission, Radio Frequency Exposure Guidelines (1996)
- National Radiological Protection Board of the United Kingdom, GS 11,1988
- American National Standards Institute (ANSI) IEEE. C95. 1-1992
- National Council on Radiation Protection and Measurements (NCRP). Report 86
- Department of Health and Welfare Canada. Safety Code 6

These standards are based on extensive scientific review. For example, over 120 scientists, engineers, and physicians from universities, government health agencies, and industry reviewed the available body of research to develop the updated ANSI standard.

The design of your phone complies with these standards when used as described under “Phone Operation” on page 8.

Antenna Care

Use only the supplied or an approved replacement antenna. Unauthorized antennas, modifications, or attachments could damage the phone and may violate local agency regulations.

Phone Operation

Normal Operation: Hold the phone as you would any other telephone. Rotate the antenna so that it points straight up. The antenna will click into place in one of two positions designed for left- or right-handed use. Make sure the antenna is fully extended. The antenna should be vertical to the ground and have a clear unobstructed view of the sky.

Tips on Efficient Operation: For your phone to operate most efficiently:

- Rotate and extend your antenna fully.
- Make sure the antenna has a clear unobstructed view of the sky.
- Do not touch the antenna unnecessarily when the phone is in use. Contact with the antenna affects call quality and may cause the phone to operate at a higher power level than otherwise needed.
- Do not wear the phone on your body while making calls with the headset accessory in satellite mode. Wearing the phone on the body can interfere with proper phone operation, since the antenna requires a clear unobstructed view of the sky to access the Iridium[®] satellite network.

Batteries

Caution: All batteries can cause property damage, injury or burns if a conductive material, such as jewelry, keys or beaded chains, touches exposed terminals. The material may complete an electrical circuit and become quite hot. To protect against such unwanted current drain, exercise care in handling any charged battery, particularly when placing it inside your pocket, purse or other container with metal objects. When the battery is detached from the phone, your batteries are packed with a protective battery cover; please use this cover for storing your batteries when not in use.

Driving

Check the laws and regulations on the use of wireless telephones in the areas where you drive. Always obey them. Observe the following guidelines when using your phone while driving.

- Give full attention to driving—driving safely is your first responsibility.
- Use hands-free phone operation, if available.
- Pull off the road and park before making or answering a call if driving conditions so require.

Electronic Devices

Most modern electronic equipment is shielded from RF signals. However, certain equipment may not be shielded against the RF signals from your wireless phone.

Pacemakers

The Health Industry Manufacturers Association recommends that a minimum separation of six inches (6") be maintained between a handheld wireless phone and a pacemaker to avoid potential interference with the pacemaker. These recommendations are consistent with the independent research by and recommendations of Wireless Technology Research.

Persons with pacemakers:

- should ALWAYS keep the phone more than six inches from their pacemaker when the phone is turned ON
- should not carry the phone in a breast pocket
- should use the ear opposite the pacemaker to minimize the potential for interference
- should turn the phone OFF immediately if you have any reason to suspect that interference is taking place

Hearing Aids

Some digital wireless phones may interfere with some hearing aids. In the event of such interference, you may want to consult your hearing aid manufacturer to discuss alternatives.

Other Medical Devices

If you use any other personal medical device, consult the manufacturer of your device to determine if it is adequately shielded from external RF energy. Your physician may be able to assist you in obtaining this information.

Turn your phone OFF in health care facilities when any regulations posted in these areas instruct you to do so. Hospitals or health care facilities may be using equipment that could be sensitive to external RF energy.

Vehicles

RF signals may affect improperly installed or inadequately shielded electronic systems in motor vehicles. Check with the manufacturer or its representative regarding your vehicle. You should also consult the manufacturer of any equipment that has been added to your vehicle.

Posted Facilities

Turn your phone OFF in any facility where posted notices so require.

Aircraft

Airline regulations prohibit using your phone while in the air. Check and comply with the policy of your airline regarding the use of your phone while the aircraft is on the ground.

Switch OFF your phone before boarding an aircraft.

Blasting Areas

To avoid interfering with blasting operations, turn your phone OFF when in a “blasting area” or in areas posted: “Turn off two-way radio.” Obey all signs and instructions.

Potentially Explosive Atmospheres

Turn your phone OFF and do not remove your battery when you are in any area with a potentially explosive atmosphere. Obey all signs and instructions. Sparks from your battery in such areas could cause an explosion or fire resulting in bodily injury or even death.

Areas with a potentially explosive atmosphere are often but not always clearly marked. They include, but are not limited to: fueling areas such as gasoline stations; below deck on boats; fuel or chemical transfer or storage facilities; areas where fuel odors are present (for example, if a gas/propane leak occurs in a car or home); areas where the air contains chemicals or particles, such as grain, dust, or metal powders; and any other area where you normally would be advised to turn off your vehicle engine.

For Vehicles Equipped with an Air Bag

An air bag inflates with great force. Do NOT place objects, including both installed or portable wireless equipment, in the area over the air bag or in the air bag deployment area. If in-vehicle wireless equipment is improperly installed and the air bag inflates, serious injury could result.

AC Travel Charger with International Plug Kit

TUV Product Services Approval only applies when the Europlug adapters are used with this product.

Die TÜV-Zulassung ist nur gültig, wenn das Gerät mit Europlug-Adaptoren verwendet wird.

Overview

This chapter provides an overview of this user's guide, your new satellite phone, and available Satellite Series™ accessories.

Guide Overview

Modes

Some phone features described in this user's guide apply only to satellite mode. Other features apply only to cellular mode (when you have an optional Cellular Cassette installed). The following conventions alert you to these features:



This symbol next to a feature name indicates that your phone must be in satellite mode to access the feature.





This symbol next to a feature name indicates that your phone must be in cellular mode to access the feature.

In addition, look for the labels **Satellite Mode** or **Cellular Mode** in the margins for information related to each mode.

Key Presses

Key presses are represented in this guide using symbols. A sequence of key presses may be shown as follows:



This means you should press  followed by  and then , in sequence, not simultaneously.

Prompts and Messages

Your phone responds to key presses by displaying either a prompt that guides you to the next action or a message confirming that your action is complete. Prompts and messages are represented in this guide in LCD style, for example: Enter PIN or Completed.

Tips

In the margins of this guide are useful hints and ways to optimize your phone's performance.









Phone Overview



Note: See pages listed after feature name for additional information.

Note: Phone shown with antenna in stowed position.

Special Keys

Key	Function
	Turns the phone's power on and off
	Selects menu settings or options, or initiates and answers calls
	Takes you directly to the Messages menu
	Stores numbers in the phone book
	Recalls numbers from the phone book
	Enters the Quick Access menu
	Enters the Options menu and scrolls forward through menu features
	Clears characters from the screen or exits the Options menu
	Scrolls backward or forward through menu features, and moves the cursor backward or forward when entering names or messages

Volume Control Keys

The volume control keys are located on the left side of the phone. They adjust earpiece and ringer volume. See “Adjust Earpiece Volume” on page 54 and “Adjust Ringer Volume” on page 55 for more information.

Satellite Antenna

When you are in satellite mode, you must rotate and fully extend the satellite antenna to answer calls, make calls, and access satellite services.* See “Holding the Phone” on page 44 for more information.

When you are in cellular mode you do not need to rotate or extend the satellite antenna.

* Satellite products require a clear line of sight to satellite.

Satellite Antenna Lock Release Button

This button releases the satellite antenna so you can attach the auxiliary antenna. You may also want to remove the satellite antenna if you spend a lot of time in cellular mode.

Cellular Cassette Connector

Insert an optional Cellular Cassette onto the back of the phone. The Cellular Cassette connector is located underneath the battery compartment cover next to the battery. The Cellular Cassette interfaces with your phone so that you can use it on the local cellular network.

Display

Your phone's Liquid Crystal Display (LCD) displays as many as four rows of 16 characters.

The LCD on your phone may respond slowly to key presses in extremely cold temperatures. This is normal and does not affect the phone operation in any way.

Headset Jack

The headset jack located on the right side of the phone provides a connection for an optional headset.

Infrared Data Port

An infrared data (IrDA) port located on the left side of the phone allows wireless communication with an external device such as a personal computer.

Accessory and Power Connector

This connector, located on the bottom of the phone, provides the connection for an external power supply or a data cable.





Indicators









Status Indicator

The status indicator is located at the top of your phone. This LED indicator provides information on your phone's current state of service depending on your mode.

If the LED is...	Then in satellite mode...	Then in cellular mode...
Alternating red and green	A call is incoming.	A call is incoming.
Flashing green	You are receiving a signal from the Iridium satellite network. You can make and receive calls.	You are receiving a signal from the cellular network. You can make and receive calls.
Flashing yellow	You are temporarily unable to receive calls.	You are roaming.
Flashing yellow and red	Your SIM card may be inserted incorrectly, may not be inserted, or you may be in a restricted area. You can make emergency calls only.	You will not see this indicator in cellular mode.
Flashing red	Service is not available.	Service is not available.

Display Status Indicators and Icons

Indicator	Description
	<p>Signal Strength Indicator indicates the strength of the signal from the network. The signal strength indicator appears continuously in the top left hand corner of the display. The more segments displayed in the bar graph, the stronger the signal. Five bars indicate full signal strength. No bars indicate a weak signal.</p>
	<p>Battery Charge Indicator indicates the strength of the battery charge. The more segments displayed, the greater the battery charge.</p> <p>When you are in satellite mode, you can also check the strength of the charge at any time through the menu. See "Viewing the Battery Meter" on page 122 for more information.</p>
	<p>Real Time Clock displays the time in either 12-hour or 24-hour format. See "Change the Time Displayed" on page 163 for more information.</p>
	<p>Message Indicator appears when you receive a new message. It flashes when the SIM card is full. See "Accessing Received Messages" on page 132 for additional information.</p>
	<p>Satellite Mode Indicator appears when your phone is in satellite mode. See "Selecting a Mode" on page 185 for more information.</p>

Indicator	Description
	<p>Home System Indicator appears in satellite mode when the phone has successfully registered with the Iridium satellite system. In cellular mode (when you have the appropriate Cellular Cassette inserted), this indicator appears when the phone is registered with your home cellular system.</p>
	<p>Roam Indicator appears when you are roaming on a cellular system (when you have the appropriate Cellular Cassette inserted). This indicator does not appear when the phone is in satellite mode.</p>
	<p>No Service Indicator appears when your phone is not capable of placing or receiving calls.</p>
	<p>In Use Indicator appears when a call is in progress.</p>
	<p>Scroll Bar appears on the right of the display when you are in a menu. The button on the scroll bar indicates where you are in the list.</p>
	<p>Check Mark indicates a menu item is currently selected.</p>
	<p>Hourglass appears in the display when your phone has to request settings from the network.</p>
	<p>Quick Access Menu Icons allow you to easily identify Quick Access features as you scroll through the Quick Access menu.</p>

Satellite Series™ Accessories

Product appearance and specifications are subject to change without notice.



Note: For maximum performance use only Motorola Original™ accessories.

Batteries

Standard Capacity Lithium Ion Battery



- Provides up to 2.4 hours of talk time or 24 hours of standby time*
- Weighs 2.3 ounces/66 grams

High Capacity Lithium Ion Battery



- Provides up to 3.6 hours of talk time or 38 hours of standby time*
- Weighs 3.4 ounces/98 grams

Ultra High Capacity Lithium Ion Battery



- Provides up to 7.6 hours of talk time or 72 hours of standby time*
- Weighs 7 ounces/200 grams

* All talk and standby times are approximate and depend on network configuration, signal strength, and the features selected.

AC Travel Charger with International Plug Kit



The AC travel charger with international plug kit provides rapid charge for optimal performance and can be used to power the phone when the battery is depleted.

- Includes four international plug adapters for use in Europe, Australia, India, and the United Kingdom
- May be used with both the 9505 portable phone and desktop charger
- Allows you to use the 9505 portable phone while recharging the battery
- Convenient self-storing cord
- Charges StarTAC[®] wireless phone when used with optional StarTAC adapter

Auto Accessory Adapter

Restores full battery power for portable phone operation or desktop charger functions from any operating vehicle (using standard 12-volt accessory connector port).



- Make and receive phone calls using the auto accessory adapter for direct power when batteries are depleted
- Recharge battery while using the desktop charger or attached to portable phone
- Charges StarTAC[®] wireless phone with optional StarTAC adapter

Headset

The convenient headset provides both an earpiece and microphone in one small unit for simple hands-free and private telephone conversations. The headset plugs directly into the jack on the right side of your phone.



Portable Auxiliary Antenna



From one car to another, this compact pocket-sized antenna with convenient magnetic mount goes in every vehicle you do to provide improved reception.

- For use with the portable phone
- Reliable magnetic mount, ceramic patch antenna
- Attached 1.5-meter (4.9 feet) cable

Note: The use of wireless devices and their accessories may be prohibited or restricted in certain areas. Always obey the laws and regulations on the use of these devices.

Antenna Adapter



This adapter provides the required external antenna connection to use your 9505 portable phone with the portable auxiliary antenna.

Carry Case



This high-quality leather case helps protect your phone. It includes a belt clip and a lanyard wrist strap.

Lanyard Wrist Strap

The lanyard wrist strap is made of nylon. It provides a convenient way to carry your phone.



Cellular Cassettes

Cellular Cassettes are modules that attach to the 9505 portable phone and provide support for various terrestrial or land-based cellular systems. With an attached Cellular Cassette, you can make and receive calls in various cellular modes, assuming service subscription and coverage are available.



Cellular Cassettes create an innovative blend of cellular and satellite technology in one phone.

- When attached to the back of the 9505 portable phone, Cellular Cassettes enable dual mode satellite and cellular operation.
- Cellular Cassettes enable flexible usage of cellular technologies and provide call delivery compatibility in areas that support cellular service.

Getting Started

Getting started with your new satellite phone is easy. Just insert your phone's SIM (Subscriber Identity Module) card and charge the battery. This chapter shows you how.

Attaching the Satellite Antenna

Attach the Antenna

1. **Attach the antenna** in the down position.
2. **Press and hold** the lock release button at the top of the phone.
3. **Push the antenna** until it clicks into place and release the button.

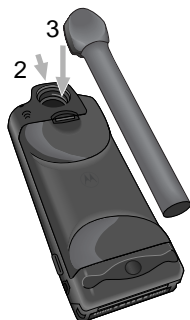

Remove the Antenna

You may want to remove the satellite antenna to attach an auxiliary antenna, or if you spend the majority of your time in cellular mode.

1. **Place the antenna** in the down position.
2. **Press the button** at the top of the phone.
3. **Remove the antenna** by pulling straight out.

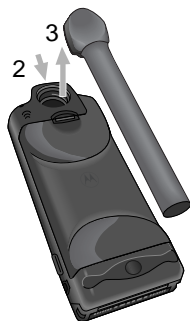

What Is a SIM Card?

Your SIM (Subscriber Identity Module) card is a small smart card that contains your phone number, service details, and memory for storing phone book entries and messages. This means you can use your SIM card with any phone for the GSM system or any Motorola product for the Iridium satellite system, and all calls go on your account.

Note: Your phone has limited functionality without the SIM card.

GSM SIM Card Capability

If you already have a GSM SIM card and your service provider has a roaming agreement with the Iridium satellite system, you can use it in your satellite telephone. You need an optional Cellular Cassette to access your local cellular/PCS service.

Note: If you are using a GSM SIM card, you may not have access to certain features that are specific to the Iridium satellite system, and vice versa.

SIM Card Protection

You may want to keep your SIM card in your wallet or purse when you are not using your satellite phone. This helps keep your personal information secure and gives you access to your service even if your phone is not available. If you forget your phone, insert your SIM card into a friend's phone to access your personal service.

Caution: Do not bend or scratch your SIM card, and avoid exposing your card to static electricity, water, or dirt.

Installing/Removing the SIM Card

The SIM card is stored in a recess in the battery compartment. It is normally covered by the battery when you use your phone.

Caution: Make sure your phone is powered off before inserting or removing the SIM card. If you don't, you may damage the memory on your SIM card.

1. **Turn your phone off** by pressing and holding the **Ⓞ** key.
2. **Remove the battery cover and battery.** (See "Remove the Battery" on page 33.)
3. **Slide the SIM card tray to the left and lift up** the right side of the tray.

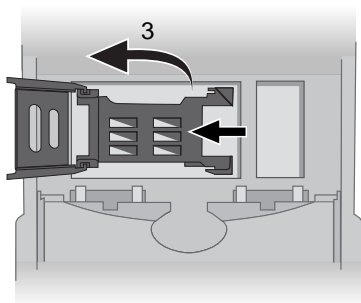

- 4. Insert the SIM card into the tray** with the notch up and the gold plate facing out.

or

Remove the SIM card from the tray.

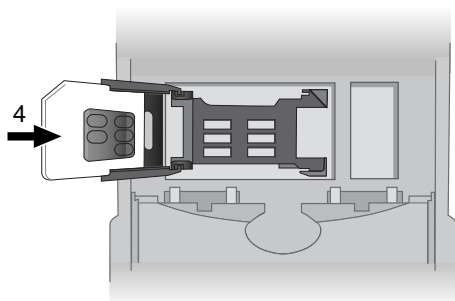

- 5. Push the SIM card tray down and slide the tray** to the right to lock it in place.

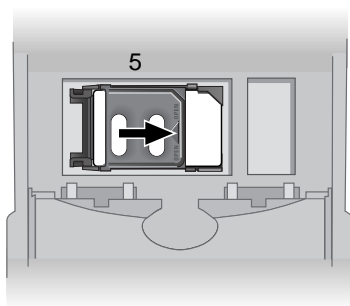

- 6. Replace the battery and battery cover.**
(See "Insert the Battery" on page 31.)

Removing the Battery Cover

Your new batteries are shipped uncharged and fitted with protective covers.

Save the covers for storing and carrying unused batteries. The covers prevent metal objects from contacting both battery terminals, which can reduce the risk of injury, or damage from a battery short circuit.

Remove the Battery Safety Cover

1. **Press in** the release latch.

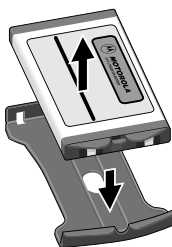

2. **Continue pushing in and upwards** until the battery slips free from its cover.

Attach the Battery Safety Cover

1. **Lower the side** opposite the latch into the cover.



2. **Slip the side** with the release latch down until it clicks.

Installing the Battery

Insert the Battery

Note: Insert only Motorola-approved batteries in your phone. If you insert an unapproved battery you will see an *Invalid Batt.* message. You are able to discharge the battery, but you cannot recharge it.

1. **Remove or rotate the satellite antenna** before installing the battery. (See “Attaching the Satellite Antenna” on page 26.)

2. **Press and hold the release latch** at the top of the battery compartment cover.

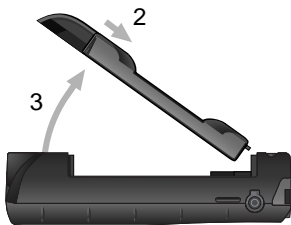

3. **Pull the cover upward**, and then remove it from the phone.

4. Align the arrows on the battery with the arrows in the battery compartment.

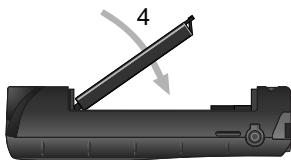

Insert the battery.

bottom end first, into the compartment, and then press the battery downward until it clicks into place.

Tip: *The battery compartment is located on the back of the phone.*

- 5. Insert the bottom end** of the battery compartment cover into the slots at the end of the compartment.

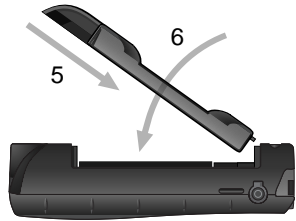

- 6. Snap the cover** down into place.

If you have an optional Cellular Cassette, see “Installing the Cellular Cassette” on page 39.

Remove the Battery

1. **Remove or rotate the satellite antenna** before removing the battery. (See “Attaching the Satellite Antenna” on page 26.)

2. **Press and hold the release latch** at the top of the battery compartment cover.

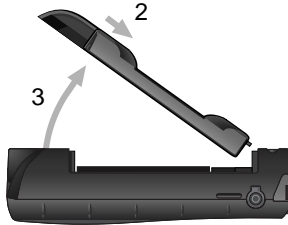

3. **Pull the cover upward**, and then remove it from the phone.

4. **Press and hold the release latch** at the base of the battery.

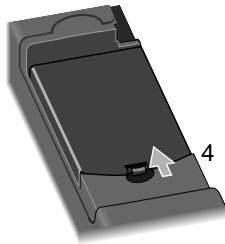

5. **Pull the battery upward** and out of the phone.

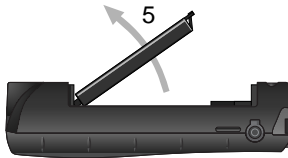

Tip: The battery compartment is located on the back of the phone.

- 6. Insert the bottom end** of the battery compartment cover into the slots at the end of the compartment.

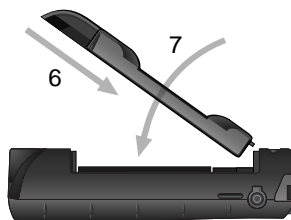

- 7. Snap the cover down** into place.

- 8. Replace** the battery safety cover. See "Attach the Battery Safety Cover" on page 30 for more information.

Charging the Battery



Any battery that hasn't been used for a month or more—including new batteries—should be charged for about 3–4 hours before use.

Using the Internal Charger

A battery charger is built right into your phone. Using either the travel charger or auto accessory adapter, you can plug the handset directly into a power source to charge the installed battery.

1. **Connect the travel charger** or auto accessory adapter to the power connector at the base of the phone.



2. **Plug the travel charger** or auto accessory adapter into the appropriate power source. The phone beeps, flashes the  (battery charge) indicator, and displays Charging Battery:
3. If the phone is powered on, **press**  to place the phone in charge-only mode.
If the phone is powered off, it automatically enters charge-only mode.

Note: You can still place and answer calls while using the internal charger. If you wish to place or answer a call:

Press  to exit charge-only mode and return to normal operation.

Remember that talking on the phone uses power, so charging takes more time.

Using the Desktop Charger

You can use the front compartment of the desktop charger to charge the battery in your phone. You can also charge a spare battery in the rear compartment. The front compartment charges first, then the charger switches to the rear compartment.

To charge:

- 1. Connect the travel charger** to the desktop charger.
- 2. Plug the travel charger** into the appropriate power source.
- 3. Insert your phone** with a battery installed.
- 4. Insert a spare battery** in the rear compartment, if desired.



Checking Battery Charge Level

Low Battery Warning

When the battery level is low and only a few minutes of talk-time remains, your phone signals you in two ways:

- Low Battery appears on the display.
- A warning tone (two double beeps) sounds.

Note: To help maintain the best battery and phone performance, recharge your battery as soon as possible after you receive the low battery warning.

View Battery Meter

The  (battery charge) indicator appears continuously in the upper right corner of the display.

You can also display a more detailed battery meter at any time to check the charge level on your battery. See “Viewing the Battery Meter” on page 122 for more information.

This feature is not available in cellular mode.

Satellite Mode

Cellular Mode

Battery Information

Maximizing Battery Life

Caution: To prevent injuries or burns, do not allow metal objects to contact or short circuit the battery terminals.

To ensure maximum battery life and use your battery to its fullest capacity, observe the following guidelines.

- Always use Motorola-approved battery chargers.
- Always use Motorola-approved batteries (Standard, High Capacity, Ultra High Capacity battery).
- Maintain the battery at or near room temperature when charging.
- When you do not plan on using a particular battery for a while, store the battery uncharged in a cool, dark, and dry place.
- To prolong the life of your batteries, avoid exposing them to temperatures below -10°C (14°F) or above 45°C (113°F).
- Always take your phone with you when you leave your car.
- Use either the Standard or High Capacity battery when the Cellular Cassette is installed; the Ultra High Capacity battery does not fit when the Cellular Cassette is installed.

Disposing of Batteries

To dispose of batteries, check with your local recycling center for a battery recycler near you. Never dispose of batteries in fire.

Installing the Cellular Cassette

You can attach an optional Cellular Cassette to your satellite phone to allow it to work with land-based cellular systems.

Insert the Cellular Cassette

- 1. Remove or rotate the satellite antenna** before installing the Cellular Cassette. (See “Remove the Antenna” on page 26.)

- 2. Press and hold the release latch** at the top of the battery compartment cover.

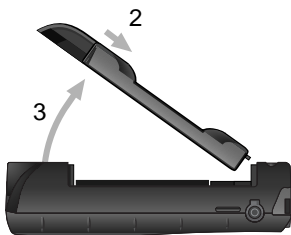

- 3. Pull the cover upward**, and then remove it from the phone.

- 4. Insert the Cellular Cassette**, bottom-end first, into the compartment on top of the battery.

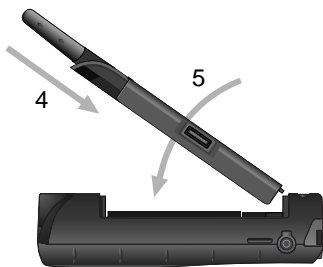

- 5. Press the Cellular Cassette downward** until it clicks into place.

- 6. Save the battery compartment cover** for future use.

Tip: *The phone switches between satellite mode and cellular mode based on your preferences. See “Selecting a Mode” on page 185.*

Tip: *You cannot use the Ultra High Capacity battery when the Cellular Cassette is installed.*

Remove the Cellular Cassette

1. **Remove or rotate the satellite antenna** before removing the Cellular Cassette. (See “Remove the Antenna” on page 26.)

2. **Press and hold the release latch** at the top of the Cellular Cassette.

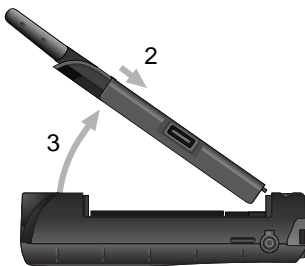

3. **Pull the Cellular Cassette upward**, and then remove it from the phone.

4. **Insert the bottom end** of the battery compartment cover into the slots at the end of the compartment.

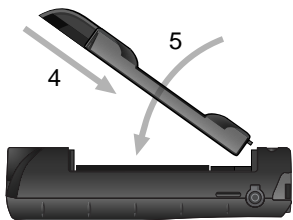

5. **Snap the cover down** into place.

If your phone was powered on when you removed your Cellular Cassette, you will see *Cassette Removed* in your display for a few moments.

Using Your Phone



Read this chapter to learn how to get up and running with your new satellite phone.

The phone features available to you vary depending on whether your phone is operating in satellite mode or cellular mode. The table below shows the features available in each mode. See “Selecting a Mode” on page 185 for more information on changing modes.

Feature	Satellite	GSM 900	GSM 900/1800	TDMA 800/1900	CDMA 1900	CDMA/AMPS
Automatic Redial	•					
Call a Phone Number in a Message	•					
Dial a Phone Number With Pauses	•	•	•	•	•	•
Dial Special Characters	•	•	•	•	•	•
Earpiece Volume: Adjust	•	•	•	•	•	•
Emergency Call	•	•	•	• ¹	• ¹	• ¹
International Dialing	•	•	•	• ¹	• ¹	• ¹
Keypad: Lock/Unlock	•	•	•	• ¹	• ¹	• ¹
Message Notification	•	•	•			
Multiple Key Answer	•	•	•	•	•	•
Phone Book: Dial a Phone Number	•	•	•	•	•	•
Phone Number: Display My Phone Number(s)	•	•	•	•	•	•
Redial Last Number Called	•	•	•	•	•	•
Ringer Volume: Adjust	•	•	•	•	•	•
Standby Mode	•	•	•	•	•	•
Unanswered Call Message	•					
1 You must set up this feature first in the Phone Setup Menu.						

Startup Procedures



Turn the Power On and Off

1. **Insert your SIM card** if necessary. (See “Installing/Removing the SIM Card” on page 28.)
2. **Press and hold**  to turn the phone on and off.
3. If your SIM card is PIN-code protected, **enter the SIM card PIN code** (a four- to eight-digit number given to you by your service provider), and then **press**  to continue.

Caution: If you enter an incorrect SIM card PIN code three times in a row, your SIM card will be disabled. See “Protecting the SIM Card” on pages 157-158 for more information.

When you turn your phone's power on, you will hear the wakeup tone (or feel a vibration if the VibraCall[®] alert function is activated) and see the wakeup screen. The wakeup screen displays a short animated sequence that reminds you to rotate and extend the antenna, and shows how to hold the phone for best reception (see illustration). You may see a number of other power-on messages (described on pages 43-44).



When the  (no service) indicator disappears and the  (home system) indicator appears, you are ready to make a call.

Power-On Messages

Once your phone is powered on, you may see:

Message	Description
Searching...	The phone is attempting to establish communications with the satellite or cellular network. See "Accessing the Network" on page 177.
Rotate and Extend Antenna	You also hear a tone when you see this message. Make sure the antenna is rotated upward and fully extended and has a clear unobstructed view of the sky.
Rotate Antenna Re-registering... or Re-registering...	Your phone is registering with the network. When the process is complete, you will see Registered . See "Accessing the Network" on page 177.
Check Signal	Your phone is unable to establish registration with the satellite network. Move to a location with a clear unobstructed view of the sky.
Invalid Account	Contact your service provider.
Enter Phone Unlock Code	Your phone was locked after the last use. Enter your four-digit unlock code and press OK to proceed. See "Locking and Unlocking Your Phone" on page 154.
Enter PIN	Enter the four- to eight-digit SIM card PIN code provided by your service provider and press OK to proceed. See "Protecting the SIM Card" on page 157.
Insert Card	Power off your phone, make sure your SIM card is inserted completely, and then power your phone on again.
Check Card	The SIM card is damaged or inserted the wrong way.

Message	Description
Blocked	If the SIM card PIN code is incorrectly entered three times in a row, your SIM card becomes blocked. See "Unblock the PIN Code" on page 158 for instructions on how to unblock it.
 Blocked	If the SIM card PIN2 code is incorrectly entered three times in a row, your SIM card becomes blocked. See "Unblock the PIN2 Code" on page 160 for instructions on how to unblock it.
Bad Card See Supplier	Your SIM card has been damaged or incorrectly issued. Contact your service provider for information.

Holding the Phone

- 1. Rotate the antenna** to either the left or right detent. The antenna will stop here.



Left Detent

Right Detent

2. **Extend the antenna** by pulling out on the end of it.

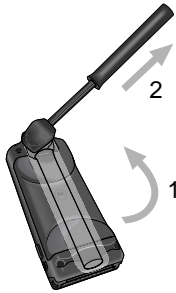

The antenna should be vertical to the ground when you talk on the phone (as shown in the following illustration from the wakeup screen animated sequence).



3. Make sure the antenna has a clear unobstructed view of the sky.

Standby Mode

To conserve energy, your phone may turn off its display backlight when you have not pressed a key for several seconds. The light reappears the next time you press a key.

Placing a Call

To place a call, your phone must be powered on, have a SIM card inserted, be unlocked, and be in contact with the satellite or cellular network (depending on your mode). See “Accessing the Network” on page 177 for network information.

You can enter a phone number up to a maximum of 20 digits. The digits are displayed in two rows, 16 digits in the top line and four digits in the next line.

Dial a Number

1. **Rotate and fully extend** the satellite antenna if you are in satellite mode. See “Holding the Phone” on page 44.
2. **Enter the number** using the digit keys. As you begin entering digits, you will see *Call?*.

When you are in satellite mode, you must enter the phone number in international format:

[international access code, 00, or +]
[country code or Iridium code]
[phone number]

Note: If you are calling another Iridium satellite subscriber, use the Iridium code instead of the country code.

3. **Press** . You will see *Calling* followed by the number you dialed.

You will see either the flashing message *Calling* or the flashing messages *Calling*, *Registering...*, and the phone will play a series of setup tones.

If the call connects and is answered, *Connected* appears on the display for a few seconds, followed by *End Call?*.

Tip: If you make a mistake, press  once to delete the last digit, or press and hold  to clear all digits.

If the call does not connect, you may see one of the following messages:

Message	Description
Rotate and Extend Antenna	Make sure the antenna is rotated upward and fully extended and has a clear unobstructed view of the sky.
Busy Try Later or Please Try Later	The phone is unable to access the network. Try again in a few minutes.
Restricted Area	The phone is unable to access the network. Move to an area where calls are allowed.
Redial?	Press  to redial the number automatically. See "Automatic Redial" on page 48 for more information.

International Dialing

To make an international phone call:

- 1. Press and hold .**

After a few seconds the international dialing prefix + appears in the display. This allows you to call from any country without knowing the local international access code.

- 2. Enter the country code** followed by the phone number. The country code follows the conventional format.

Note: If you are in TDMA or CDMA cellular mode, you must set up the international dialing prefix in order for this feature to work. See "Set Up an International Prefix" on page 172 for more information.

Satellite Mode

Automatic Redial

If the number or your network is busy, you will see **Redial?** for five seconds.

Press  to redial the number automatically.



Note: Your phone makes a maximum of ten redial attempts. If the call cannot be connected within this maximum, you will see the message **Redial Failed**.

Cellular Mode

This feature is not available in cellular mode.







Redial Last Number Called

Whenever your phone is on standby, you can redial the last number called:

1. **Press**  to display the last number dialed.
2. **Press**  again to place the call.

Dial Special Characters

You can insert special characters in your numbers:

To enter...	Then...
	Press  .
*	Press  .
† (for international calls)	Press and hold  .
▣ (for pause dialing)	Press and hold  .
supplementary service numbers, PINs, and unblocking	Press  or  one or more times as necessary.

Dial a Number With Pauses

See “Using Pauses in Numbers” on page 84 for information on dialing numbers with pauses.

Dial a Number from the Phone Book

Your phone contains a phone book that you can use to store names and telephone numbers. Once you have stored information in your phone book, you can save dialing steps by:

- using one-touch dialing (page 101)
- recalling and dialing an entry by location (page 88)
- recalling and dialing an entry by name (page 87)
- recalling and dialing one of the last ten numbers called (page 97)

See “Managing the Phone Book” on page 75 for information on how to store and retrieve names and numbers from the phone book.

Make an Emergency Call

You can make an emergency call virtually anywhere in the world (without unlocking your phone) by dialing 112. Provided your phone has found a network, you are able to make an emergency call. The emergency call is directed to a central emergency operator.

To make an emergency call:

Dial **1** **1** **2nd**.

You will see the message **Emergency Calls**.

In addition, your Iridium service provider may have provided an additional emergency calling code on your SIM card. Check with your service provider.

Note: If you are in TDMA or CDMA cellular mode, you may have to set up the emergency number in order for this feature to work. See “Set Up the Emergency Number” on page 171 for more information.

Satellite Mode

Cellular Mode



Call a Number in a Message

For details on how to call a phone number embedded in a message, see “Return a Call” on page 135.

This feature is not available in cellular mode.

End a Call

Use one of the following procedures to end a call:

- **Press**  when you see the End Call? prompt in the display.
- **Press** .

Receiving a Call

Receive a Phone Call

To receive a call, your phone must be powered on, have a SIM card inserted, be unlocked, and be in contact with the satellite or cellular network (depending on your mode). See “Accessing the Network” on page 177 for network information.

There are two scenarios for receiving calls in satellite mode, depending on the antenna position:

- (1) antenna raised and fully extended, or
- (2) antenna stowed or in the down position.

Antenna Raised and Fully Extended

When you receive a call:

- Your phone rings and/or vibrates.
- The status indicator alternates red and green.
- The phone displays **Call**, followed by **Answer?** on the next line.

To answer the call:

Press **OK** or any digit key (**1** - **9**, **0**, ***** or **#**).

You will see **Connected**.

If the call does not connect properly, you may see one of the following messages:

Message	Description
Orient Antenna Call Attempt	You need to fully extend the antenna upwards with a clear unobstructed view of the sky.
Call Failed	The antenna is not properly adjusted or the network signal is not strong enough.

Tip: See page 153 to set your phone's alert.

Antenna Stowed or in the Down Position

When you receive a call:

- The phone chirps up to three times to alert you of an incoming call.
- The phone displays **Rotate Antenna**, followed by **Call Attempt** on the next line.

You must rotate and extend the antenna as quickly as possible to receive the call.

Rotate and fully extend the antenna as described in "Placing a Call" on page 46.

You will see **Iridium Call Attempt**. Do not attempt to answer until the phone rings or vibrates.

After several seconds, your phone will ring or vibrate and display **Call** followed by **Answer?** on the next line.

To answer the call:

Press  **or any digit key** ( -  ,  or ).



You will see **Connected**.

If the call does not connect properly, you may see one of the following messages:

Message	Description
Orient Antenna Call Attempt or Rotate Antenna Call Attempt	You need to fully extend the antenna upwards with a clear unobstructed view of the sky.
Call Failed	The antenna is not properly adjusted or the network signal is not strong enough.

End a Call

Use one of the following procedures to end a call:

- **Press**  when you see the End Call? prompt in the display.
- **Press** .

Unanswered Calls

If you are away from your phone or choose not to answer a call, your phone displays the message Unanswered Call.

This feature is not available in cellular mode.

Personal Mailbox

Callers who are unable to reach you can leave numeric, text, and voice messages. The next time you register with the satellite network or GSM cellular network (depending on your mode), you will receive these messages. Then you will have the option of returning the call or saving the message for later viewing.

For information on retrieving messages, see “Accessing Received Messages” on page 132.

This feature is not available in TDMA or CDMA cellular mode.

Satellite Mode

Cellular Mode

Satellite Mode

Cellular Mode

(GSM 900/1800)

(GSM 900)

Cellular Mode

(TDMA 800/1900)

(CDMA 1900)

(CDMA/AMPS)

Additional Phone Features

Lock and Unlock the Keypad

To prevent accidental usage of the phone, press the **#** and ***** keys simultaneously to lock the keypad. All keys with the exception of the **⓪** key are disabled. You can still answer an incoming call by pressing **OK** when the keypad is locked.

To remove the keypad lock, press **#** and ***** simultaneously.

Adjust Earpiece Volume

To adjust earpiece volume:

- **Increase the volume** by pressing the upper volume control key.
- **Decrease the volume** by pressing the lower volume control key.

As you press the keys, the phone's speaker demonstrates the new volume level. The bar graph in the display represents the volume level. The higher the graph, the louder the volume.

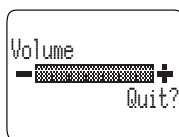

Note: You can also use the volume control keys to scroll through phone book entries. See page 87 for more information.

Tip: The volume control keys are located on the side of the phone.

Adjust Ringer Volume

To adjust the ringer volume:

Press  and then the up or down volume control key.

The phone sounds the new volume level as you adjust it.

Note: You can also use the Phone Setup menu to adjust ringer volume. See page 152 for more information.

View Your SIM Card Phone Number

To retrieve and view your phone number from your SIM card:

Press  .

Notes:

- If you do not see your phone number, the number has not been programmed onto your SIM card. You can program your phone number onto your SIM card by following the steps described in “Modify Your Phone Number(s)” on page 100.
- You can also use the Phone Book menu to view your phone number. See page 99 for more information.

Tip: The volume control keys are located on the left side of the phone.

Using In-Call Features

Read this chapter to learn how to use In-Call menu features. The In-Call menu is displayed when you press  during a call. See “Using the In-Call Menu” on page 72 for more information.

The feature selection on the In-Call menu varies depending on your mode setting. The table below shows the features available in each mode. See “Selecting a Mode” on page 185 for more information on changing modes.

Feature	Satellite	GSM 900/ 1800	GSM 900	TDMA 800/1900	CDMA 1900	CDMA/ AMPS
Call Waiting	•	•		Service Provider ¹	Service Provider ¹	Service Provider ¹
Conference Call	•			Service Provider ¹	Service Provider ¹	Service Provider ¹
Call Holding	•	•		Service Provider ¹	Service Provider ¹	Service Provider ¹
Call Muting	•	•	• ²	• ²	• ²	• ²
Phone Flash				•	•	•

1 Your service provider may offer similar or additional features.
2 This feature must be activated from the Quick Access menu in this cellular mode.

Muting a Call



Satellite Mode Cellular Mode (GSM 900/1800)



Tip: You can also mute the phone from the Quick Access menu. See "Using the Quick Access Menu" on page 70.

Cellular Mode (GSM 900) (TDMA 800/1900) (CDMA 1900) (CDMA/AMPS)



For privacy during a call, try muting the phone. You hear the party on the other end, but the other party does not hear you.

To mute a call in progress:

1. Press  until you see Turn Mute on or off.
2. Press  to select. You will see Mute followed by End Call? on the next line.



Caution: You cannot press  a second time to unmute the phone. If you press  when the phone is muted, you will end the call.

To unmute a call:



1. Press  until you see Turn Mute on or off.
2. Press  to select.

The In-Call menu is not available in these cellular modes. You must activate call muting from the Quick Access menu in these cellular modes.

To mute a call in progress:

1. Press .
2. Press  to scroll to Mute, then press  to select.





To unmute a call:

1. Press .
2. Press  to scroll to Mute, then press  to select.

Using Call Waiting

Note: You must subscribe to this network feature through your service provider. Contact your service provider for additional information.

If you have subscribed to Call Waiting, you must first activate it through the Options menu. (See “Activating Call Waiting” on page 116.) After you activate it, you are notified of incoming calls while you are on the line in two ways. When a call comes in, you hear a beep and see the message Call Waiting followed by Answer?.

If you want to...	Then...
accept the waiting call	Press  . Your current call is placed on hold.
reject the waiting call	Press  .
end current call before answering the waiting call	1. Press  . You will see End Active Call. 2. Press  . Your phone rings and can now be answered normally.

You may see one of the following messages during call waiting activities:

Message	Description
Trying	Your phone is attempting to switch between the current and held call.
Hold Failed	The attempt to hold a call was unsuccessful.
Cannot Hold Second Call	A call is already on hold. You can only place one call on hold.
Reconnect Failed	The held call could not be made active again.
Busy Try Later	Your phone is working on a previous command. Wait a short time before repeating the new command.

This feature is not available in GSM 900 cellular mode.

Satellite Mode
Cellular Mode
(GSM 900/1800)

Cellular Mode
(GSM 900)

Cellular Mode
(TDMA 800/1900)
(CDMA 1900)
(CDMA/AMPS)

TDMA and CDMA cellular users who have subscribed to this feature are notified of an incoming call by two beeps. You may see a message in your display, depending on your service provider.



To handle the waiting call, you must send a phone flash along with the appropriate feature code provided by your service provider. The current call is put on hold. To return to your initial call you must send another phone flash. For instructions on how to send a phone flash, see “Sending a Phone Flash” on page 66.

Placing a Call on Hold







Note: You must subscribe to this network feature through your service provider. Contact your service provider for additional information.

You can place a call on hold to receive a new call or while making a new call. You can only place one call on hold at a time, so some options may not be accessible if you have already placed a call on hold.



To place a call on hold:

1. **Press**  until you see Hold Call.
2. **Press** . Your current call is put on hold and you will see Call Holding followed by Reconnect?.

Once your call is on hold, you have these options:

If you want to...	Then...
make a new call	<ol style="list-style-type: none">1. Press  until you see Make New Call, and then press  to select.2. Dial the number as usual, and then press  to place the call.
switch between calls	When you are connected to either number, you will see 2 Calls followed by Switch?. Press  to switch to the other call and automatically place the current call on hold.
end both calls	Press  until you see End Active & Held Call, and then press  to select. Both calls are disconnected, and the display returns to standby.
end current call	Press  at any time.

Satellite Mode
Cellular Mode
(GSM 900/1800)

If you want to...	Then...
end call that is on hold	Press  until you see End Held Call , and then press  to select. The held call is disconnected, the current call remains connected, and you see End Call? .

You may see one of the following messages:

Message	Description
Trying	Your phone is attempting to switch between the current and held call.
Hold Failed	The attempt to hold a call was unsuccessful.
Cannot Hold Second Call	A call is already on hold. You can only place one call on hold.
Reconnect Failed	The held call could not be made active again.
Busy Try Later	Your phone is working on a previous command. Wait a short time before repeating the new command.

Cellular Mode
(GSM 900)

Cellular Mode
(TDMA 800/1900)
(CDMA 1900)
(CDMA/AMPS)

This feature is not available in GSM 900 cellular mode.

To place a call on hold, you must send a phone flash along with the appropriate feature code provided by your service provider. To return to your initial call, you must send another phone flash. For instructions on how to send a phone flash, see “Sending a Phone Flash” on page 66.





Making a Conference Call

Note: You must subscribe to this network feature through your service provider. Contact your service provider for additional information.





This feature lets you participate in a conference call of up to five parties.

To make a conference call, you must be engaged in an active call and have another call on hold. You can do this by accepting a waiting incoming call during an active call, or by placing an active call on hold and making a second call.





To begin a conference call:

1. **Press**  until you see *Conference Call*.
2. **Press** . Your phone joins your current call with your held call, and you will see *Conference* followed by *End Call?*

While in a conference call, you have these options:

If you want to...	Then...
place the active call on hold	Press  until you see <i>Hold Call</i> , and then press  to select. Your current call is put on hold and you will see <i>Call Holding</i> followed by <i>Reconnect?</i> .
make a new call	<ol style="list-style-type: none"> 1. Press  until you see <i>Make New Call</i>, and then press  to select. 2. Dial the number as usual, and then press  to place the call. <p>If you want to add the new party to the conference call, repeat steps 1 and 2 for beginning a conference call as described above.</p>

Satellite Mode

If you want to...	Then...
<p>hold a private conversation with one of the conference call participants</p>	<ol style="list-style-type: none"> Press  until you see Split Call, and then press  to select. You will see the name of the first party added to the conference call. Press  to scroll through the list of call participants until you find the party you want to talk to, then press  to select. <p>The selected party becomes the active call, with the other parties placed on hold.</p> <p>To return the private call to the conference call, repeat the steps for making a conference call as described on page 63.</p>
<p>end conference call</p>	<p>Press  at any time.</p>

You may see one of the following messages:

Message	Description
<p>Conference Unsuccessful</p>	<p>One of your calls is already engaged in a conference call controlled by a remote party</p> <p>or</p> <p>The attempt to join the held call and the active call was unsuccessful.</p>
<p>Conference Full</p>	<p>You already have the maximum number of five callers joined in a conference call.</p>
<p>Split Call Unsuccessful</p>	<p>You already have an active call and a call on hold</p> <p>or</p> <p>The attempt to split the call was unsuccessful</p>

Keypad Controls

Many conference call features are directly accessible by entering specific key sequences on the keypad during a call:

If you want to...	Then...
begin a conference call	Press 3 DEF OK .
add a single call to a conference call	Press 3 DEF OK .
hold a private conversation with one participant	Press 2 ABC [call number] OK (Where [call number] is the sequential order in which the call was placed or received.)
place active call on hold, accept held or waiting call	Press 2 ABC OK .
release a specific conference call participant	Press 1 [call number] OK . (Where [call number] is the sequential order in which the call was placed or received.)
end all held calls (no waiting call)	Press 0 + OK .
end all active calls, accept held or waiting call	Press 1 OK .

This feature is not available in GSM cellular mode.

To make a conference call or access conference call options, you must send a phone flash along with the appropriate feature code provided by your service provider. For instructions on how to send a phone flash, see "Sending a Phone Flash" on page 66.

Cellular Mode
(GSM 900/1800)
(GSM 900)

Cellular Mode
(TDMA 800/1900)
(CDMA 1900)
(CDMA/AMPS)

Sending a Phone Flash

Satellite Mode

Cellular Mode

(GSM 900/1800)

(GSM 900)

Cellular Mode

(TDMA 800/1900)



(CDMA 1900)

(CDMA/AMPS)

This feature only applies to TDMA or CDMA cellular mode.

Many TDMA and CDMA cellular network features (for example, call waiting, call holding, call forwarding) require you to send a “phone flash” over the air during a call to access them. This is similar to when you press the switch hook on your conventional phone in your home or office to switch between calls. The phone flash alerts the network that you want to use a particular network feature. Your service provider will provide you with the appropriate codes to send with the phone flash for the features to which you have subscribed.

To send a phone flash:

1. **Press**  while you are in a call. You will see **Flash Options** followed by **Select?**.
2. **Press** . You will see **Send Flash?**.
3. **Enter the access code** for the feature you want to access, if necessary, and then **press**  to send the flash.

or

Press  to cancel the flash.

Using the Menus

Many of your phone's features are organized into lists of options called *menus*. There are three menus:

- The main **Options menu** lets you select and/or adjust phone features.
- The **Quick Access menu** gives you instant access to the menu features you use most frequently.
- The **In-Call menu** gives you access to call-related features when you are in a call.







Some options give you access to additional lists of options called *submenus*.

Using the Options Menu

The Options menu gives you access to your phone's features and options. You can *not* access this menu during a call. The submenus that appear under the Options Menu vary depending on your mode setting. See "Selecting a Mode" on page 185 for more information on changing modes.

Navigate the Options Menu



Learning how to use just a few keys enables you to move freely through the entire menu system.

If you want to...	Then...
enter the Options menu	Press  . You will see the first available submenu.
scroll through the Options menu	<ul style="list-style-type: none">• Press  to scroll forward.• Press  to scroll backward or forward.
select options and submenus	Press  to select a menu option or submenu when that option or submenu name is displayed.
exit features and menus	<ul style="list-style-type: none">• Press  to exit the feature or submenu.• Press and hold  to exit the Options menu.







Note: If you press  during a call in satellite mode or GSM 900/1800 cellular mode, you will see the In-Call menu, which is described on page 72.

How the Phone Responds

As you scroll through the Options menu, you will see one of three questions on the bottom line of the display.

If your phone asks...	Then...
View Options?	Press  to enter the submenu.
Select?	Press  to select the displayed feature.
Quit?	Press  to exit the feature.

Display Messages and Indicators

If you see...	Then...
 Completed	This indicates a feature has been activated.
 Failed	The display returns to the menu in a few seconds.
Enter PIN or Enter Name	Enter requested information, then press  .
 Busy Try Later	You may have requested information while your phone was completing another task.
	The scroll bar indicates where you are in a menu.
	Your phone may take a few seconds to request settings from the network.

Customize the Options Menu

To personalize the Options menu—to hide and move features—see “Move Menu Features” on page 200.

Using the Quick Access Menu

The Quick Access menu is a way to keep your favorite menu options readily accessible. Each digit key, **1** to **9**^{WXYZ}, is matched to a Quick Access feature. See the table on page 71 for the default setup.

If you know the number of the feature, activating that option takes only two button presses! If you do not know the number or want to review your options, just scroll through the icon menu and read the tag attached to each option.



Activate the Feature Directly

To access the feature directly:

Press , and then **press** the digit key of the feature.









Scroll to the Feature

To scroll to the feature:

1. **Press** .
2. **Press**  to scroll through the available features.
3. **Press**  to select a feature.

Default Quick Access Settings

The following features (and associated icons) are the default settings for the Quick Access menu.

Key	Icon	Quick Access Feature
1		Find Name searches your phone book by the full name.
2 ABC		Mute mutes and unmutes a call in progress.
3 DEF		Call Voicemail ¹ calls your voicemail number to check your voicemail.
4 GHI		Battery Meter displays a fuel gauge indicating charge. The more bars, the greater the charge.
5 JKL		Lock Now locks your phone immediately.
6 MNOP		Vibrate On/off activates or deactivates the VibraCall [®] alert function.
7 PQRS		Read Messages displays the newest message received.
8 TUV		Register Now initiates a search for the Iridium satellite network. You must wait three minutes between registration attempts.
9 WXYZ		Forward On/Off ¹ activates or deactivates unconditional call forwarding depending on the current setting.

1 You must subscribe to this network feature through your service provider. Contact your service provider for additional information.

Customize the Quick Access Menu

See “Personalizing the Quick Access Menu” on page 202 for instructions on how to modify the feature selection on the Quick Access menu.

Using the In-Call Menu

This menu lets you access specific features while you are in a call. The In-Call menu is only available when you are in a call. You cannot review it off-line.

Entering the In-Call Menu

While you are in a call:

Press  to view the In-Call menu features.

In-Call Menu Features

The In-Call menu dynamically changes depending on the type of call you are in and the mode you have selected.

The following options appear on the In-Call menu in satellite mode.

Satellite Mode

Type of call	Options
single active call	Hold Call Make New Call Turn Mute on or off
held call	Make New Call End Held Call
active call and a call waiting	End Active Call Reject Call Waiting Turn Mute on or off
active call and a held call	End Active Call Turn Mute on or off End Held Call End Active & Held Call Conference Call
held call and a call waiting	Reconnect Held Call Reject Call Waiting End Held Call?

Type of call	Options
active call, held call, and a call waiting	End Active Call 2 Calls Switch Turn Mute on or off End Held Call End Active & Held Call Conference Call
single active conference call	Hold Call Make New Call Turn Mute on or off Split Call
active conference call and a call waiting	End Active Call Reject Call Waitings Turn Mute on or off Split Call
(conference call) active call and a held call	End Active Call Turn Mute on or off End Held Call End Active & Held Call Conference Call
(conference call) active call, held call, and a call waiting	End Active Call 2 Calls Switch Turn Mute on or off End Held Call End Active & Held Call Conference Call

Cellular Mode
(GSM 900/1800)

The following options appear on the In-Call menu in GSM 900/1800 cellular mode.

Type of call	Options
single active call	Hold Call Make New Call Restrict My Phone Number (see page 125 for more information) Turn Mute on or off
held call	Make New Call Restrict My Phone Number (see page 125 for more information) End Held Call
active call and a call waiting	End Active Call Reject Call Waiting Turn Mute on or off
active call and a held call	End Active Call Turn Mute on or off End Held Call End Active & Held Call
held call and a call waiting	Reject Call Waiting End Held Call?
active call, held call, and a call waiting	End Active Call Turn Mute on or off End Held Call End Active & Held Call

Cellular Mode
(GSM 900)

This menu is not available in GSM 900 cellular mode.

Cellular Mode
(TDMA 800/1900)
(CDMA 1900)
(CDMA/AMPS)

When you press  during a call in TDMA or CDMA cellular mode, you will see Flash Options followed by Select?.

Managing the Phone Book

Your satellite phone can store up to 100 names and numbers, and your SIM card expands memory capacity even more.

You can use the dedicated keys or the Phone Book menu to add and retrieve numbers from the phone book. With the Phone Book menu you can also access phone book maintenance and security features.

The feature selection on the Phone Book menu varies depending on your mode setting. The table below shows the features available in each mode. See “Selecting a Mode” on page 185 for more information on changing modes.

Feature	Satellite	GSM 900/ 1800	GSM 900	TDMA 800/1900	CDMA 1900	CDMA/ AMPS
Add Entry: Phone Memory/SIM Memory	•	•	•	•	•	•
Check Capacity: Phone Memory/SIM Memory	•					
Find Entry By Name: Call/Modify/Erase	•	•	•	•	•	•
Find Entry By Location: Call/Modify/Erase	•	•	•	•	•	•
Fixed Dialing: View/Activate/Edit/Add/Erase	•					
Last Ten Calls: View Made/Erase	•					
Last Ten Calls: View Received/View Made/Erase		•	•	•	•	•
My Phone Number(s): View/Modify	•	•	•	•	•	•
One-Touch Dialing: Phone Memory/SIM Memory/Fixed Dial List	•					
One-Touch Dialing: Phone Memory/SIM Memory		•	•	•	•	•
Pause Dialing (non- menu item)	•	•	•	•	•	•
Phone Number Prefixes (non-menu item)	•					
Prevent Access to Phone Book: Phone Memory/SIM Memory/Both	•					
Show Service Phone Numbers	•					

Phone Book Menu

Satellite Mode

Phone Book

- Personal Numbers
 - Find Entry By Name
 - Enter Name:
 - Call Number
 - Modify Name Or Number
 - Erase Name And Number
 - Find Entry By Location
 - Enter Location:
 - Call Number
 - Modify Name Or Number
 - Erase Name And Number
 - Add Entry
 - Add To Phone Memory
 - Add To SIM Card Memory
 - Check Capacity
 - Check Phone Capacity
 - Check SIM Capacity
 - Prevent Access
 - No Memory Restrictions
 - To Phone Memory
 - To SIM Card Memory
 - To Phone & SIM Memory
- Show Services
- Last Ten Calls
 - Last Calls Made
 - Erase All Numbers
- My Phone Number(s)
- Fixed Dialing
 - View Fixed Dial List
 - Setup Fixed Dialing
 - On/Off
 - Edit Entry
 - Add Entry
 - Erase Entry
- One-Touch Dial Setting
 - To Phone Memory
 - To SIM Card Memory
 - To Fixed Dial List

Phone Book

- Personal Numbers
 - Find Entry By Name
 - Enter Name:
 - Call Number
 - Modify Name Or Number
 - Erase Name And Number
 - Find Entry By Location
 - Enter Location:
 - Call Number
 - Modify Name Or Number
 - Erase Name And Number
 - Add Entry
 - Add To Phone Memory
 - Add To SIM Card Memory
- Last Ten Calls
 - Last Calls Received
 - Last Calls Made
 - Erase All Numbers
- My Phone Number(s)
- One-Touch Dial Setting
 - To Phone Memory
 - To SIM Card Memory

Cellular Mode

Organizing Your Phone Book

Each name and phone number in your phone book is stored in a numbered memory location. The satellite phone has two types of memory—phone memory and SIM card memory.

	Phone Memory	SIM Card Memory ¹
Personal Numbers	100 entries	155 entries
Fixed Dial Numbers	No entries	40 entries
Phone Number Digits	32	20
Name Characters	16	16
Location Numbers	1-100	101-255

¹ SIM card capacity varies depending upon the card issued by your service provider.

Your phone's memory can seem overwhelming if you do not have a strategy for organizing your phone book. Begin setting up your phone book by asking yourself three questions:

Which numbers do I call most?

Make a list of the numbers you call most frequently. You will probably want to store these numbers in the first nine memory locations of your phone book. You can then dial them with a single keystroke by using one-touch dialing (satellite mode only).

When do I use these numbers?





Group the numbers on the list according to when you use them. Most people call a different set of numbers during the day than they do in the evening and on weekends. You can switch one-touch dialing to your phone's memory (locations 1–9), your SIM card's memory (locations 101–109), or to your fixed dial list (locations 1–9). Store your evening and weekend numbers on one type of memory and your daytime numbers on another.

Which numbers do I need to keep secure?

Use your SIM card to store the numbers you need to keep secure, like the numbers of friends and family members. You can remove your SIM card and keep it securely in your wallet or purse when you are not using your phone. If you wish, you can even require a PIN code every time your SIM card is inserted into *any* phone. (To deactivate your PIN code, see “Activate and Deactivate the SIM Card PIN Code” on page 157.) Store more public numbers, like business associates and travel agents in your phone's memory.

Tip: *If you have many entries, group them in blocks of ten to make them easier to find.*









Getting to Personal Numbers...

1. Press  until you see Phone Book, and then press .
2. Press  to scroll to Personal Numbers, and then press .
3. Press  to scroll to one of the features described below.

Storing Names and Numbers

Add an Entry







Use the Options Menu

1. Follow the steps in “Getting to Personal Numbers...” to get to Add Entry, and then press .
 2. Press  to scroll to Add To Phone Memory or Add To SIM Card Memory.
 3. Press  to select. You will see Enter Number.
 4. Enter a number, and then press . You will see Enter Name.
 5. Enter a name (as described in “Entering Names” on page 82), and then press . You will see Enter Location.
 6. Enter a one-, two-, or three-digit location number (1-100 for phone memory or 101-255 for SIM memory*), and then press . You will see Stored XXX.
- or
- Press  to select the next available location. You will see Stored XXX.
7. Press and hold  to exit the menu.

Tip: When in satellite mode, numbers should be entered in international format.

* SIM memory is dependent on your SIM card.

Use the Dedicated Keys

1. **Enter the phone number** you want to store.
2. **Press**  to begin storing.
3. **Press**  to scroll to Add To Phone Memory or Add To SIM Card Memory, and then **press** . You will see Enter Number, followed by the number you entered.
4. **Press**  to accept the number. You will see Enter Name.
5. **Enter a name** (as described in “Entering Names” on page 82), and then **press** . You will see Enter Location.
6. **Enter a one-, two-, or three-digit location number**, and then **press** . You will see Stored XXX.

or

Press  to store the entry in the next empty memory location. You will see Stored XXX.

Adding Entry Messages

When you enter the location number for your entry, you may see one of these messages:

Message	Description
Stored XXX	You have stored the entry.
Range XXX-XX	You have chosen a memory location outside the appropriate range. Enter a new number within the range listed on the display.
Overwrite?	You have chosen an occupied location. Press  to overwrite the location or press any other key to try another location.

Tip: If you have more than one number for the same person, try attaching a descriptive tag to the name, like Home, Office, or Mobile.

Entering Names

You can use the keypad to produce any letter in the alphabet. For example, press **2^{ABC}** to enter the letters A, B, or C, as shown:

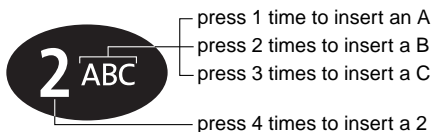

Tip: Press and hold any numeric key to toggle between uppercase and lowercase characters.

Enter Characters

1. **Enter a letter** by pressing a key as many times as necessary.
2. Press **⬆** to advance the cursor.
3. **Repeat steps 1 and 2** as many times as necessary, and then press **OK**.

Correct an Entry

To **delete** a character:

1. Press **⬆** to scroll the cursor to the right of the character you want to delete.
2. Press **C** to delete one character at a time.

or

Press and hold C to clear the display.

To **add** a character:

1. Press **⬆** to scroll the cursor to the location where you want to add a character.
2. **Enter a letter** by pressing a key as many times as necessary.

Available Characters

Use this chart as a guide for producing characters:

1

Space . ! ? ! , @ _ & : " () ' ` ; i % £ \$
Space . ! ? ! , @ _ & : " () ' ` ; i % £ \$

2 ABC

A B C 2 Ä Å à æ ß Ç
a b c 2 ä å à æ ß ç

3 DEF

D E F 3 Δ É è Φ
d e f 3 Δ é è Φ

4 GHI

G H I 4 Γ ì
g h i 4 Γ ì

5 JKL

J K L 5 Λ
j k l 5 Λ

6 MNO

M N O 6 Ñ Ö ø Ò Ω
m n o 6 ñ ö ø ò Ω

7 PQRS

P Q R S 7 Π Β Σ
p q r s 7 Π Β Σ

8 TUV

T U V 8 Θ Û ù
t u v 8 Θ ù ù

9 WXYZ

W X Y Z 9 Ξ Ψ
w x y z 9 Ξ Ψ

0 +

+ - 0 x * / = > < #
+ - 0 x * / = > < #



The upper line for each key shows the uppercase characters. The lower line for each key shows the lowercase characters.

Using Pauses in Numbers

Tip: You can store 32 characters in a phone memory location, or 20 characters in a SIM card memory location. A pause is equal to one character.

When you call automated systems, a recorded message prompts you for numbers such as PIN numbers and account numbers. You can store these numbers in the same memory location as the automated system's access number. Separate the numbers with "pauses"—special characters that tell your phone to wait a few seconds before sending additional numbers—and store the string in the same way you would other numbers.

Enter Pauses in Numbers

1. **Enter the phone number** you use to access the automated system.
2. **Press and hold** . You will see a  (pause) character inserted into the number entry.
3. **Enter the next group of numbers.** For example, enter your PIN number. If the automated system requires a * or #, enter those symbols, too.
4. **Repeat steps 2 to 3** as many times as necessary.
5. **To store the entry** follow the procedures in "Add an Entry" on page 80.

Dial Numbers With Pauses

To dial a number with pauses in satellite mode or GSM cellular mode:

1. **Recall the entry.** (See “Locating Entries” on page 87.)
2. **Press**  to place the call.

The first pause in the number waits until the call is answered. When the automated system answers, your phone waits a few seconds and then automatically sends the next set of numbers, then the next, until all numbers are sent.

To dial a number with pauses in TDMA or CDMA cellular mode:

1. **Recall the entry.** (See “Locating Entries” on page 87.)
2. **Press**  to place the call.

The first pause in the number waits until the call is answered.

The phone then waits for you to send the next set of numbers. You will see *Send Digits?*.

3. **Press**  to send the next set of digits.
4. **Repeat step 3** until all the digit sequences are sent.

Satellite Mode
Cellular Mode
(GSM 900/1800)
(GSM 900)

Tip: *Your phone displays up to 32 digits (two rows of 16 digits) when you enter a number with pauses.*

Cellular Mode
(TDMA 800/1900)
(CDMA 1900)
(CDMA/AMPS)

Using Phone Number Prefixes

Satellite Mode

You can save time when you dial by storing the prefixes that you often use. This is sometimes called “postscripting.” Your satellite phone allows you to change or add to phone book entries without overwriting them.

Store a prefix in your phone book just as you would any other number. See “Storing Names and Numbers” on page 80.



Use a Stored Prefix

To use a stored prefix:

1. **Recall the prefix** from your phone book. (See “Locating Entries” on page 87.)
2. **Add** the remaining numbers.
3. **Press**  to place the call.

Change Entry to a Similar Number

To change an entry to a similar number:





1. **Recall the number** from your phone book. (See “Locating Entries” on page 87.)
2. **Press**  to delete the unwanted digits.
3. **Enter** the replacement digits.
4. **Press**  to place the call.

Cellular Mode

This feature is not available in cellular mode.

Tip: Try naming the prefix by area, like Downtown, Suburbs, or Germany.

Getting to Personal Numbers...



1. Press  until you see Phone Book, and then press .
2. Press  to scroll to Personal Numbers, and then press .
3. Press  to scroll to one of the features described below.

Locating Entries



Find an Entry by Name

Search your phone book by the first few letters of the entry.





Note: If you have restricted access to either SIM card or phone memory and you are in satellite mode, those entries will not be available. For more information, see “Preventing Access to the Phone Book” on page 91.

1. **Follow the steps in** “Getting to Personal Numbers...” to get to Find Entry By Name, and then press  to select. You will see Enter Name.
2. **Enter one or more characters** of the entry, and then press . If necessary, scroll to the entry you are looking for.
3. Press  to access options for that entry, and then proceed to “Calling, Modifying, or Erasing an Entry” on page 89.

Tip: Your phone sorts SIM card memory and phone memory together alphabetically.

Tip: Use the , , or , or volume control keys to scroll through phone book entries.



Getting to Personal Numbers...

1. Press  until you see Phone Book, and then press .
2. Press  to scroll to Personal Numbers, and then press .
3. Press  to scroll to one of the features described below.

Find an Entry by Location

Find an entry by its location number.



Use the Options Menu

1. **Follow the steps in** “Getting to Personal Numbers...” to get to Find Entry By Location, and then press  to select. You will see Enter Location.
2. **Enter the one-, two-, or three-digit location number**, and then press . You will see the entry displayed.

If you enter an empty location number, you will see Location XXX is Empty. Your phone then selects the next available location. If no numbers are stored, you will see No Numbers Stored.

3. Press  to access options for that entry, and then proceed to “Calling, Modifying, or Erasing an Entry” on page 89.

Use the Dedicated Keys

1. Press . You will see Enter Location.
2. **Enter the one-, two-, or three-digit location number** of the entry, and then press . You will see the entry displayed.



If you enter an empty location number, you will see Location XXX is Empty. Your phone then selects the next available location.

3. Press  to call the displayed entry. You will see the number followed by Calling.





Calling, Modifying, or Erasing an Entry

Once you have selected a phone book entry, you can call, change, or erase that entry.



Call a Selected Entry

1. **Find an entry**, and then **press** . (See “Locating Entries” on page 87.)
2. **Press**  until you see **Call Number**, and then **press** . You will see **Calling** followed by the number you dialed.

Modify a Name or Number





1. **Find an entry**, and then **press** . (See “Locating Entries” on page 87.)
2. **Press**  until you see **Modify Name Or Number**, and then **press** . You will see **Edit Number**, followed by the phone number stored in that entry.
3. **Enter changes** to the number, and then **press** . You will see the name stored in that entry.
4. **Enter changes** to the name, and then **press** . You will see **Modified XXX**.

Erase a Name and Number

1. **Find an entry**, and then **press** . (See “Locating Entries” on page 87.)
2. **Press**  until you see **Erase Name And Number**, and then **press** . You will see **Erased xxx**.

Tip: For help entering letters or changing entries, see “Entering Names” on page 82.





Getting to Personal Numbers...

1. Press  until you see Phone Book, and then press .
2. Press  to scroll to Personal Numbers, and then press .
3. Press  to scroll to one of the features described below.

Checking Phone Book Capacity

Satellite Mode

Use this feature to see how many available memory locations you have in either SIM card memory or phone memory.

1. **Follow the steps in** “Getting to Personal Numbers...” to get to Check Capacity, and then press  to select.
2. Press  until you see Check Phone Capacity or Check SIM Capacity, and then press . You will see XXX Unused Locations.
3. **Press and hold**  to exit the menu.





Cellular Mode

This feature is not available in cellular mode.

Preventing Access to the Phone Book

You may want to restrict memory access when loaning your phone to others. You can choose to prevent access to the phone memory, SIM memory, or both.

Caution: If you switch to cellular mode these restrictions will not apply.

1. **Follow the steps in** “Getting to Personal Numbers...” to get to Prevent Access, and then **press**  to select.
2. **Press**  until you see the restriction type you desire: No Memory Restrictions, To Phone Memory, To SIM Card Memory, or To Phone & SIM Memory.
3. **Press**  to select the displayed option. You will see Enter Security Code.
4. **Enter security code.** Enter your six-digit security code. You will see Completed.
5. **Press and hold**  to exit the menu.

Note: If you restrict access to either phone memory or SIM memory and try to access an entry stored in that type of memory, you will see a list of the entries that are not restricted. If you prevent access to both your phone memory and SIM memory and then try to access an entry, you will see Restricted.





This feature is not available in cellular mode. When you switch to cellular mode, the restrictions you set in satellite mode will not apply.

Satellite Mode

Tip: The factory default security code is: 000000.

Cellular Mode

Getting to Fixed Dialing...

1. Press  until you see Phone Book, and then press .
2. Press  to scroll to Fixed Dialing, and then press .
3. Press  to scroll to one of the features described below.

Restricting Phone Use

Satellite Mode

Tip: You should have received your SIM card PIN2 code from your service provider.





Cellular Mode

You can restrict calling on your phone to a list of numbers that you create. When the fixed dialing feature is active, you can only call numbers or use prefixes (for example, country codes or area codes) that exactly match those stored in your fixed dial list. You can store up to 40 entries on your list. These entries are stored on your SIM card.

Activate Fixed Dialing

Use this feature to activate fixed dialing. For instructions on how to store entries in the fixed dial list, see “Add an Entry” on page 93.









Note: The fixed dialing feature restricts access to your SIM memory.

1. **Follow the steps in** “Getting to Fixed Dialing...” to get to Setup Fixed Dialing, and then press  to select. You will see Enter PIN2.
2. **Enter code.** Enter your SIM card PIN2 code, and then press .
3. Press  until you see On or Off, and then press . You will see Completed.
4. **Press and hold**  to exit the menu.

This feature is not available in cellular mode. You must deactivate the fixed dialing feature from satellite mode in order to make and receive calls in cellular mode.

Add an Entry

To add an entry to the fixed dial list:

1. **Follow the steps in** “Getting to Fixed Dialing...” to get to **Setup Fixed Dialing**, and then **press**  to select. You will see **Enter PIN2**.
2. **Enter code**. Enter your SIM card PIN2 code, and then **press** .
3. **Press**  until you see **Add Entry**, and then **press** . You will see **Enter Number**.
4. **Enter the number**, and then **press** . You will see **Enter Name**.
5. **Enter the name**, and then **press** . You will see **Enter Location**.
6. **Enter a location number**, and then **press** . You will see **Completed**.
7. **Press and hold**  to exit the menu.

This feature is not available in cellular mode. You must deactivate the fixed dialing feature from satellite mode in order to make and receive calls in cellular mode.





Satellite Mode

Tip: Phone numbers must be in international format.

Tip: See “Entering Names” on page 82 for help entering letters.

Cellular Mode

Getting to Fixed Dialing...

1. Press  until you see Phone Book, and then press .
2. Press  to scroll to Fixed Dialing, and then press .
3. Press  to scroll to one of the features described below.







Satellite Mode

Tip: You should have received your SIM card PIN2 code from your service provider.

Cellular Mode

Erase an Entry











To erase an entry in the fixed dial list:

1. **Follow the steps in** “Getting to Fixed Dialing...” to get to Setup Fixed Dialing, and then press  to select. You will see Enter PIN2.
2. **Enter code.** Enter your SIM card PIN2 code, and then press .
3. Press  until you see Erase Entry, and then press  to select. You will see the first entry in your fixed dial list.
4. Press  to scroll to the number you wish to erase. You will see Erase?.
5. Press  to confirm. You will see Completed.
6. Press and hold  to exit the menu.

This feature is not available in cellular mode. You must deactivate the fixed dialing feature from satellite mode in order to make and receive calls in cellular mode.

Edit an Entry

To edit an entry in the fixed dial list:





1. **Follow the steps in** “Getting to Fixed Dialing...” to get to **Setup Fixed Dialing**, and then **press**  to select. You will see **Enter PIN2**.
2. **Enter code**. Enter your SIM card PIN2 code, and then **press** .
3. **Press**  until you see **Edit Entry**, and then **press**  to select. You will see the first entry in your fixed dial list.
4. **Press**  to scroll to the entry you want to change, and then **press** . You will see the current number for that location.
5. **Enter changes** to the number, and then **press** . You will see the current name for that location.
6. **Enter changes** to the name, and then **press** . You will see the current location.
7. **Enter a new location**, and then **press** . You will see **Completed**.
8. **Press and hold**  to exit the menu.

This feature is not available in cellular mode. You must deactivate the fixed dialing feature from satellite mode in order to make and receive calls in cellular mode.

Satellite Mode

Cellular Mode



Getting to Fixed Dialing...

1. Press  until you see Phone Book, and then press .
2. Press  to scroll to Fixed Dialing, and then press .
3. Press  to scroll to one of the features described below.

Satellite Mode

View Your Fixed Dialing List

This feature enables you to review, but not change, your fixed dial list.

1. **Follow the steps in** “Getting to Fixed Dialing...” to get to View Fixed Dial List, and then press  to select. You will see the first number on your fixed dial list.
2. Press  to scroll through the numbers on your fixed dial list.
3. **Press and hold**  to exit the menu.

Cellular Mode

This feature is not available in cellular mode. You must deactivate the fixed dialing feature from satellite mode in order to make and receive calls in cellular mode.

Getting to Phone Book Features...

1. Press **MENU** until you see Phone Book, and then press **OK**.
2. Press **MENU** to scroll to one of the features described below. You will see the feature name, followed by Select?.

Viewing the Last Ten Calls Made or Received

Your phone saves the last ten phone numbers you have dialed. In cellular mode, your phone also saves the numbers of the last ten calls you have received.

To view the phone numbers of the last ten calls you have made:

1. **Follow the steps in** “Getting to Phone Book Features...” to get to Last Ten Calls, and then press **OK** to select.
2. Press **MENU** to scroll to Last Calls Made or Erase All Numbers, and then press **OK** to select.
3. If you select Last Calls Made, press **MENU** to scroll to the number you are looking for, and then press **OK** to place a call to that number.

or



If you select Erase All Numbers, you will see Completed.

4. Press and hold **C** to exit the menu.

Satellite Mode

Tip: If you want to add a number from Last Ten Calls to your phone book, press **M+** when the number is displayed, then follow the steps in “Storing Names and Numbers” on page 80.





Getting to Phone Book Features...

1. Press  until you see Phone Book, and then press .
2. Press  to scroll to one of the features described below.

Cellular Mode

Tip: If you want to add a number from Last Ten Calls to your phone book, press  when the number is displayed, then follow the steps in “Storing Names and Numbers” on page 80.

To view the phone numbers of the last ten calls you have made or received:



1. Follow the steps in “Getting to Phone Book Features...” to get to Last Ten Calls, and then press  to select.
2. Press  to scroll to Last Calls Received, Last Calls Made, or Erase All Numbers, and then press  to select.
3. If you select Last Calls Received or Last Calls Made, press  to scroll to the number you are looking for, and then press  to place a call to that number.

or
If you select Erase All Numbers, you will see Completed.
4. Press and hold  to exit the menu.

Viewing and Modifying Your Phone Numbers

View Your SIM Card Phone Number(s)



You can program up to three phone numbers (such as your voice and data phone numbers) onto your SIM card. Use this feature to view your phone number(s).

1. **Follow the steps in** “Getting to Phone Book Features...” to get to My Phone Number(s).
2. **Press**  to select. You will see your phone’s voice phone number followed by Modify?.
3. **Press**  to scroll through your numbers.
4. **Press and hold**  to exit the menu.

Note: If you do not see your phone number(s), they have not been programmed onto your SIM card. You can program your voice phone number and other phone numbers onto your SIM card by following the steps described in “Modify Your Phone Number(s)” on page 100.







Tip: Pressing   also brings up your phone number.

Getting to Phone Book Features...

1. Press  until you see *Phone Book*, and then press .
2. Press  to scroll to one of the features described below. You will see the feature name, followed by *Select?*.

Modify Your Phone Number(s)

Use this feature to modify or program your voice phone number onto your SIM card. You can also program other phone numbers (for example, a data phone number) onto your SIM card. You can have up to three phone numbers.

1. Follow the steps in “Getting to Phone Book Features...” to get to *My Phone Number(s)*.
2. Press  to select. You will see your phone’s voice phone number followed by *Modify?*.
3. Press  to scroll to the number you want to modify.
4. Press  to modify the number. You will see *Edit Number* followed by the number for the selected entry.
5. Enter changes to the number, and then press . You will see *Edit Name* followed by the name for the entry selected.
6. Enter changes to the name (as described in “Entering Names” on page 82) and then press . You will see *Stored*.
7. Press and hold  to exit the menu.





Using One-Touch Dialing

One-touch dialing enables you to place calls instantly. You can choose to dial the phone numbers in the first nine memory locations in either your SIM memory, phone memory, or your fixed dial list. You choose which type of memory you want to be active with this feature.

Note: You must be in satellite mode to use one-touch dialing. However, while the phone is in cellular mode, you can set the memory type that will be active with one-touch dialing.





Set Up One-Touch Dialing

To set the active memory for one-touch dialing:

1. **Follow the steps in** “Getting to Phone Book Features...” to get to **One-Touch Dial Settings**, and then **press**  to select.
2. **Press**  to scroll through **To Phone Memory**, **To SIM Card Memory**, or **To Fixed Dial List**, and then **press**  to select the displayed option. You will see **Completed**.
3. **Press and hold**  to exit the menu.

Note: When your phone is in cellular mode, you can set either SIM memory or phone memory to be the active memory for one-touch dialing. You cannot activate the fixed dial list memory from this mode.



To set the active memory for one-touch dialing when your phone is in cellular mode:

1. **Follow the steps in** “Getting to Phone Book Features...” to get to **One-Touch Dial Settings**, and then **press**  to select.
2. **Press**  to scroll to **To Phone Memory** or **To SIM Card Memory**, and then **press**  to select the displayed option. You will see **Completed**.
3. **Press and hold**  to exit the menu.

Satellite Mode

Cellular Mode

Getting to Phone Book Features...

1. Press  until you see Phone Book, and then press .
2. Press  to scroll to one of the features described below. You will see the feature name, followed by Select?.

Satellite Mode

Tip: You do not need to press  to call the number when you use one-touch dialing.

Cellular Mode

Use One-Touch Dialing

To use one-touch dialing:



Press and hold the appropriate digit key.

For example, press and hold  to dial the number stored in location 2 of your phone memory, location 2 of your fixed dial list, or 102 of your SIM memory, depending on your setting.

You must be in satellite mode to use one-touch dialing. However, while the phone is in cellular mode, you can set the memory type that will be active with one-touch dialing.

Viewing Service Phone Numbers

This feature provides a read-only list of service phone numbers that are pre-programmed by your service provider. The list resides on the SIM card and allows for call placement only.

1. **Follow the steps in** “Getting to Phone Book Features...” to get to **Show Services**.
2. **Press**  to select. You will see a list of service phone numbers.
3. **Press**  to scroll to the number you are looking for.
4. **Press**  to place a call to that number.

or

Press and hold  to exit the menu.

Note: If you do not see any service dialing number(s), they have not been programmed onto your SIM card. Contact your service provider for more information.

This feature is not available in cellular mode.

Satellite Mode

Cellular Mode

Using Calling Features

This chapter describes call-related features. Many of these features are network features that you must subscribe to in order to access.

The feature selection on the Call Related Features menu varies depending on your mode setting. The table below shows the features available in each mode. See “Selecting a Mode” on page 185 for more information on changing modes.

Feature	Satellite	GSM 900/ 1800	GSM 900	TDMA 800/1900	CDMA 1900	CDMA/ AMPS
Battery Meter: Show	•					
Call Barring: Change Bar Password	•	•	•			
Call Barring: Incoming Calls	•	•	•			
Call Barring: Incoming Calls When Roaming		•	•			
Call Barring: Outgoing Calls/Outgoing International Calls/ Outgoing International Calls Except Home	•	•	•	Service Provider ¹	Service Provider ¹	Service Provider ¹
Call Forwarding: All Calls/When Unavailable/Data Calls	•	•	•	Service Provider ¹	Service Provider ¹	Service Provider ¹
Call Forwarding: Voice Calls/Voice if Busy/Voice If No Answer/Voice If Not Reachable	•	•	•	Service Provider ¹	Service Provider ¹	Service Provider ¹
Call Waiting: Activate	•	•	•	Service Provider ¹	Service Provider ¹	Service Provider ¹
Pending Call Drop: Deactivate	•			Service Provider ¹	Service Provider ¹	Service Provider ¹
Phone Number ID: Send/Restrict		•				
Signal Strength: Show	•					
1 Your service provider may offer similar or additional services.						

Call Related Features Menu

Satellite Mode

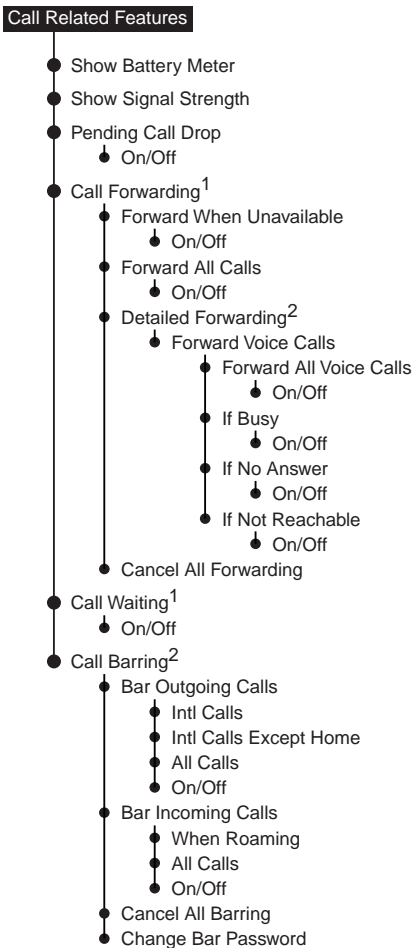

1 This feature is network and subscription dependent.

2 This feature is network and subscription dependent. It is available only when the extended menus are activated.

Call Related Features

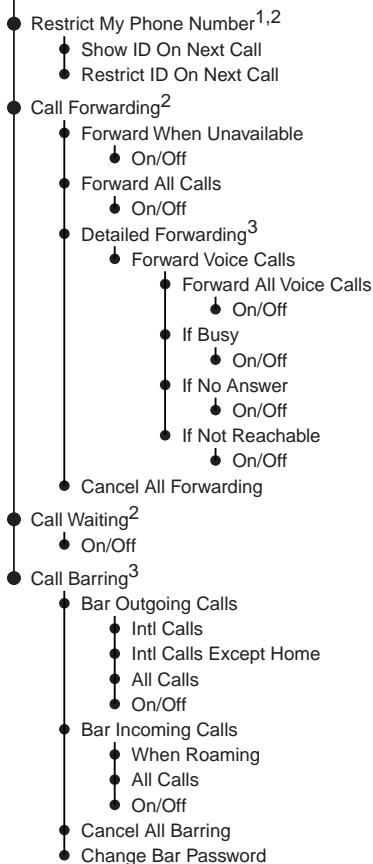

1 This feature is available only in GSM 900/1800 cellular mode.

2 This feature is network and subscription dependent.





3 This feature is network and subscription dependent. It is available only when the extended menus are activated.

This menu is not available in TDMA or CDMA cellular mode.

Cellular Mode
(GSM 900/1800)
GSM 900)

Cellular Mode
(TDMA 800/1900)
(CDMA 1900)
(CDMA/AMPS)

Getting to Call Forwarding...

1. Press  until you see Call Related Features, and then press .
2. Press  to scroll to Call Forwarding, and then press .
3. Press  to scroll to one of the features described below.







Forwarding Calls When Unavailable

Use this feature when you are unable to answer your phone calls.

Note: You must subscribe to this network feature through your service provider. Contact your service provider for additional information.





Satellite Mode

To activate this feature in satellite mode:

1. **Follow the steps in** “Getting to Call Forwarding...” to get to Forward When Unavailable, and then press  to select. Your phone takes a moment to request the current setting from the network.
2. Press  to scroll to On or Off, and then press  to select.
 - If you select On, continue with **step 3**.
 - If you select Off, continue with **step 5**.
3. Press  to scroll to Voicemail or Other Number, and then press  to select.
 - If you select Voicemail, continue with **step 5**.
 - If you select Other Number, then you will see Enter Number. Continue with **step 4**.
4. **Enter the number** you want calls forwarded to, and then press .
5. **Press and hold**  to exit the menu.

Tip: If you have not yet stored a voicemail number, go to page 144 to learn how.

To activate this feature in GSM cellular mode:





- 1. Follow the steps in** “Getting to Call Forwarding...” to get to Forward When Unavailable, and then **press**  to select. Your phone takes a moment to request the current setting from the network.
- 2. Press**  to scroll to On or Off, and then **press**  to select.
 - If you select On, you will see Enter Number. Continue with **step 3**.
 - If you select Off continue with **step 4**.
- 3. Enter the number** you want calls forwarded to, and then **press** . You will see Call Forward On.
- 4. Press and hold**  to exit the menu.

To activate call forwarding features in TDMA or CDMA cellular mode, you must send a phone flash along with the appropriate feature code provided by your service provider. For instructions on how to send a phone flash, see “Sending a Phone Flash” on page 66.

Cellular Mode
(GSM 900/1800)
(GSM 900)

Cellular Mode
(TDMA 800/1900)
(CDMA 1900)
(CDMA/AMPS)

Getting to Call Forwarding...

1. Press  until you see Call Related Features, and then press .
2. Press  to scroll to Call Forwarding, and then press .
3. Press  to scroll to one of the features described below.





Forwarding All Your Calls

Satellite Mode



This feature forwards all of your calls to the number you choose. Your phone does not ring.

Note: You must subscribe to this network feature through your service provider. Contact your service provider for additional information.





To activate this feature in satellite mode:

1. **Follow the steps in** “Getting to Call Forwarding...” to get to Forward All Calls, and then press  to select. Your phone takes a moment to request the current setting from the network.
2. Press  to scroll to either On or Off, and then press  to select.
 - If you select On, your phone takes a moment to contact the network and update the setting. You will see Call Forward On. Continue with **step 3**.
 - If you select Off, continue with **step 5**.
3. Press  to scroll to Voicemail or Other Number, and then press  to select.
 - If you select Voicemail, continue with **step 5**.
 - If you select Other Number, then you will see Enter Number. Continue with **step 4**.

Tip: If you have not yet stored a voicemail number, go to page 144 to learn how.

4. **Enter the number** you want calls forwarded to, and then **press** .
5. **Press and hold**  to exit the menu.

To activate this feature in GSM cellular mode:





1. **Follow the steps in** “Getting to Call Forwarding...” to get to **Forward All Calls**, and then **press**  to select. Your phone takes a moment to request the current setting from the network.
2. **Press**  to scroll to either **On** or **Off**, and then **press**  to select.
 - If you select **On**, your phone takes a moment to contact the network and update the setting. You will see **Call Forward On**, followed by **Enter Number**. Continue with **step 3**.
 - If you select **Off**, continue with **step 4**.
3. **Enter the number** you want calls forwarded to, and then **press** .
4. **Press and hold**  to exit the menu.

To activate call forwarding features in TDMA or CDMA cellular mode, you must send a phone flash along with the appropriate feature code provided by your service provider. For instructions on how to send a phone flash, see “Sending a Phone Flash” on page 66.

Cellular Mode
(GSM 900/1800)
(GSM 900)

Cellular Mode
(TDMA 800/1900)
(CDMA 1900)
(CDMA/AMPS)

Getting to Call Forwarding...

1. Press  until you see Call Related Features, and then press .
2. Press  to scroll to Call Forwarding, and then press .
3. Press  to scroll to one of the features described below.

Using Detailed Call Forwarding





This feature lets you select the specific situations when you want your calls forwarded. The Forward When Unavailable and Forward All Calls features override the settings you select here.

Notes:





- You must subscribe to this network feature through your service provider. Contact your service provider for additional information.
- This feature is available only when the extended menus are activated. See “Activating Extended Menus” on page 161.

Voice Calls





To forward voice calls in satellite mode:

1. **Follow the steps in** “Getting to Call Forwarding...” to get to Detailed Forwarding, and then press  to select. Your phone takes a moment to request the current setting from the network.
2. Press  to scroll to Forward Voice Calls, and then press  to select.
3. Press  to scroll to the option you desire: Forward All Voice Calls, If Busy, If No Answer, or If Not Reachable.

Satellite Mode

4. **Press**  to select the displayed option. Your phone takes a moment to contact the network and update the setting. You will see Call Forward On.
5. **Press**  to scroll to either Voicemail or Other Number, and then **press** .
 - If you select Voicemail, continue with **step 7**.
 - If you select Other Number, then you will see Enter Number. Continue with **step 6**.
6. **Enter the number** you want calls forwarded to, and then **press** .
7. **Press and hold**  to exit the menu.



To forward voice calls in GSM cellular mode:

1. **Follow the steps in** “Getting to Call Forwarding...” to get to Detailed Forwarding, and then **press** .
2. **Press**  to scroll to Forward Voice Calls, and then **press**  to select. Your phone takes a moment to request the current setting from the network.
3. **Press**  to scroll to the option you desire: Forward All Voice Calls, If Busy, If No Answer, or If Not Reachable. Your phone takes a moment to contact the network and update the setting. You will see Call Forward On.
4. **Press**  to select the displayed option.
 - If you select If Busy or If Not Reachable, your calls are automatically forwarded to your Personal Mailbox. Continue with **step 6**.
 - If you select Forward All Voice Calls or If No Answer, you will see Enter Number. Continue with **step 5**.

Tip: *If you have not yet stored a voicemail number, go to page 144 to learn how.*





Cellular Mode
(GSM 900/1800)
(GSM 900)

Cellular Mode
(TDMA 800/1900)
(CDMA 1900)
(CDMA/AMPS)

- 5. Enter the number** you want calls forwarded to, and then press .
- 6. Press and hold**  to exit the menu.

To activate call forwarding features in TDMA or CDMA cellular mode, you must send a phone flash along with the appropriate feature code provided by your service provider. For instructions on how to send a phone flash, see “Sending a Phone Flash” on page 66.

Getting to Call Forwarding...

1. Press  until you see Call Related Features, and then press .
2. Press  to scroll to Call Forwarding, and then press .
3. Press  to scroll to one of the features described below.

Canceling All Forwarding

This feature cancels all call forwarding settings in satellite mode or GSM cellular mode.

Note: You must subscribe to this network feature through your service provider. Contact your service provider for additional information.

1. **Follow the steps in** “Getting to Call Forwarding...” to get to Cancel All Forwarding, and then press  to select.

Your phone takes a moment to contact the network and update the setting. You will see Call Forward Off. All call forwarding settings are now set to Off.



2. **Press and hold**  to exit the menu.

To cancel call forwarding settings in TDMA or CDMA cellular mode, you must send a phone flash along with the appropriate feature code provided by your service provider. For instructions on how to send a phone flash, see “Sending a Phone Flash” on page 66.

Satellite Mode
Cellular Mode
(GSM 900/1800)
(GSM 900)

Cellular Mode
(TDMA 800/1900)
(CDMA 1900)
(CDMA/AMPS)

Getting to Call Related Features...





1. Press  until you see Call Related Features, and then press .
2. Press  to scroll to one of the features described below.

Activating Call Waiting

Satellite Mode
Cellular Mode
(GSM 900/1800)
(GSM 900)

If you subscribe to call waiting, use this feature to specify whether or not you want to be notified of incoming calls while you in a call.

Note: You must subscribe to this network feature through your service provider. Contact your service provider for additional information.

1. **Follow the steps in** “Getting to Call Related Features...” to get to Call Waiting, and then press  to select.
2. Press  to scroll to On or Off, and then press  to select the desired option.
3. **Press and hold**  to exit the menu.

For information on using call waiting, see “Using Call Waiting” on page 59.

Cellular Mode
(TDMA 800/1900)
(CDMA 1900)
(CDMA/AMPS)

You do not have to activate call waiting through the menu system in TDMA or CDMA cellular mode. For information on using call waiting in TDMA or CDMA cellular mode, see “Using Call Waiting” on page 59.





Restricting Calls with Call Barring

You can use call barring to restrict both incoming and outgoing calls. Call barring is useful if you are loaning your phone to others or when you wish to control incoming calls. When you change one of your call barring settings, your phone takes a few seconds to request the setting from the network.

Notes:

- You must subscribe to this network feature through your service provider. Contact your service provider for additional information.
- This feature is available only when the extended menus are activated. See “Activating Extended Menus” on page 161.

Getting to Call Barring...

1. Press  until you see Call Related Features, and then press .
2. Press  to scroll to Call Barring, and then press .
3. Press  to scroll to one of the features described below.

Satellite Mode Cellular Mode (GSM 900/1800) (GSM 900)





Tip: Your service provider gives you a bar password.

Cellular Mode (TDMA 800/1900) (CDMA 1900) (CDMA/AMPS)

Bar Outgoing Calls

This feature enables you to receive incoming calls but prevents outgoing calls.

To bar outgoing calls in satellite mode or GSM cellular mode:

1. Follow the steps in “Getting to Call Barring...” to get to Bar Outgoing Calls, and then press  to select.
2. Press  to scroll to Intl Calls, Intl Calls Except Home, All Calls, or Off, and then press  to select. You will see Enter Password.
3. Enter your bar password, and then press . You will see Completed.
4. Press and hold  to exit the menu.





Note: You cannot bar international calls in satellite mode. However, you can cancel the Bar Outgoing Calls/Intl Calls or Bar Outgoing Calls/Intl Calls Except Home feature in satellite mode if the feature was previously activated in GSM cellular mode.

This feature is not available in TDMA or CDMA cellular mode.

Bar Incoming Calls

This feature allows you to place calls, but refuses incoming calls. Callers hear a recording telling them that you are unavailable. To be sure not to miss a call, see “Using Detailed Call Forwarding” on page 112.

To bar incoming calls in satellite mode or GSM cellular mode:

1. **Follow the steps in “Getting to Call Barring...”** to get to Bar Incoming Calls, and then **press**  to select.
2. **Press**  to scroll to When Roaming, All Calls, or Off, and then **press**  to select. You will see Enter Password.
3. **Enter your bar password**, and then **press** . You will see Completed.
4. **Press and hold**  to exit the menu.





Note: The Bar Incoming Calls/When Roaming feature does not apply in satellite mode. However, you can cancel the Bar Incoming Calls/When Roaming feature in satellite mode if the feature was previously activated in GSM cellular mode.

This feature is not available in TDMA or CDMA cellular mode.

Satellite Mode
Cellular Mode
(GSM 900/1800)
(GSM 900)

Cellular Mode
(TDMA 800/1900)
(CDMA 1900)
(CDMA/AMPS)

Getting to Call Barring...

1. Press  until you see Call Related Features, and then press .
2. Press  to scroll to Call Barring, and then press .
3. Press  to scroll to one of the features described below.

Satellite Mode

Cellular Mode

(GSM 900/1800)

(GSM 900)

Cellular Mode



(TDMA 800/1900)

(CDMA 1900)

(CDMA/AMPS)

Cancel All Barring





To cancel all call barring settings in satellite mode or GSM cellular mode:

1. **Follow the steps in "Getting to Call Barring..."** to get to Cancel All Barring, and then press  to select. You will see Enter Password.
2. **Enter your bar password**, and then press . You will see Call Barring Off. All call barring settings are now set to Off.
3. **Press and hold**  to exit the menu.

This feature is not available in TDMA or CDMA cellular mode.

Change Bar Password

When you subscribe to call barring, your service provider gives you a four-digit bar password. Use this feature to change it to something easy to remember.

1. **Follow the steps in** “Getting to Call Barring...” to get to Change Bar Password, and then **press**  to select. You will see Enter Password.
2. **Enter your bar password**, and then **press** . You will see Enter New Password.
3. **Enter the new bar password**, and then **press** .
4. **Enter the new bar password** again to confirm, and then **press** .
5. **Press and hold**  to exit the menu.



This feature is not available in TDMA or CDMA cellular mode.

Satellite Mode
Cellular Mode
(GSM 900/1800)
(GSM 900)

Tip: *If you are changing the password for the first time, use the password supplied by your service provider.*

Cellular Mode
(TDMA 800/1900)
(CDMA 1900)
(CDMA/AMPS)

Getting to Call Related Features...

1. Press  until you see Call Related Features, and then press .
2. Press  to scroll to one of the features described below.

Viewing the Battery Meter

Satellite Mode

Use this feature to check the charge level on your battery.

1. **Follow the steps in** “Getting to Call Related Features...” to scroll to Show Battery Meter, and the **press**  to select.

You will see the battery meter:

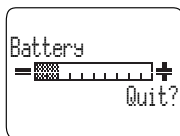

Low Charge

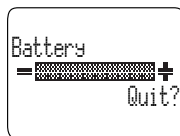

High Charge

You may also see one of the following messages:

Message	Description
Not Available	The battery meter doesn't appear because a battery is not installed.
Charging Battery	The battery is being charged.
Fast Charge Completed	The battery has completed charging.
Invalid Batt.	You have an unapproved battery inserted in your phone.

2. **Press and hold**  to exit.

Cellular Mode

This feature is not available in cellular mode.

Viewing Signal Strength

Use this feature to check the strength of the signal that your phone is receiving from the Iridium satellite network.

1. **Follow the steps in** “Getting to Call Related Features...” to get to Show Signal Strength.
2. **Press**  to select. You will see Checking Signal....

If the antenna is not rotated, you will see Rotate and Extend Antenna. Rotate and extend the antenna to continue.

The signal strength indicator is located in the upper left corner of the display:



Signal strength is sampled every four to five seconds; the indicator shows the average strength for the last three samples. The more segments displayed in the bar graph, the stronger the signal. Five bars indicate full signal strength. The indicator shows the tower icon but no bars when the signal is weak.



3. **Press and hold**  to exit the menu.

This feature is not available in cellular mode.

Satellite Mode

Cellular Mode

Getting to Call Related Features...





1. Press  until you see Call Related Features, and then press .
2. Press  to scroll to one of the features described below.

Deactivating Pending Call Drop Signal

Satellite Mode

Under rare circumstances, due to system overcapacity or a satellite outage, a satellite may not be available to take your call. When this happens, your phone notifies you with a series of three consecutive tones and displays Pending Call Drop. The tones continue periodically until a new satellite moves into range or the call is dropped.

To activate or deactivate the alert tones:

1. **Follow the steps in the** “Getting to Call Related Features...” to get to Pending Call Drop, and then **press**  to select.
2. **Press**  to scroll to either On or Off, and then **press**  to select.
3. **Press and hold**  to exit the menu.

Cellular Mode

This feature is not available in cellular mode.

Restricting Your Phone Number ID



This feature is not available in satellite mode.



Note: You must subscribe to this network feature through your service provider. Contact your service provider for additional information.

If your phone number is normally sent with each call (so that a recipient with calling line identification can see your number), select **Restrict ID On Next Call** to prevent your number from being sent with the next attempted call. If your phone number is normally restricted with each call, select **Show ID On Next Call** to send your number with the next attempted call.

Your phone reverts to its standard behavior after the call attempt is made.

To send or restrict your phone number on your next call attempt:

- 1. Follow the steps in the** “Getting to Call Related Features...” **to get to Restrict My Phone Number, and then press**  **to select.**
- 2. Press**  **to scroll to Show ID On Next Call, and then press**  **to select.**

or
Press  **to scroll to Restrict ID On Next Call, and then press**  **to select.**
- 3. Press and hold**  **to exit the menu.**

This feature is not available in GSM 900 cellular mode, TDMA cellular mode, or CDMA cellular mode.

Satellite Mode

Cellular Mode
(GSM 900/1800)

Cellular Mode
(GSM 900)
(TDMA 800/1900)
(CDMA 1900)
(CDMA/AMPS)

Using Message Services

You can receive voicemail notification messages, and send and receive numeric and text messages through your Personal Mailbox service—around the world. Wherever you are, you can have instant reference to all your communication.

The feature selection on the Messages menu varies depending on your mode setting. The table below shows the features available in each mode. See “Selecting a Mode” on page 185 for more information on changing modes.

Feature	Satellite	GSM 900/ 1800	GSM 900	TDMA 800/1900	CDMA 1900	CDMA/ AMPS
Incoming Message Notification (non-menu item)	•	•	•			
Outgoing Message: Create/Send/Store	•					
Outgoing Message: Set Service Center	•					
Outgoing Message: Set Expiration Period	•					
Outgoing Message: Set Message Type	•					
Read A New Message (non-menu item)	•	•	•			
Stored Messages: Read/Go to Next/Delete	•	•	•			
Stored Messages: Edit/Return Call	•					
Voicemail: Call	•	•	•	•	•	•
Voicemail Number: Enter	•	•	•	•	•	•

Messages Menu

Satellite Mode

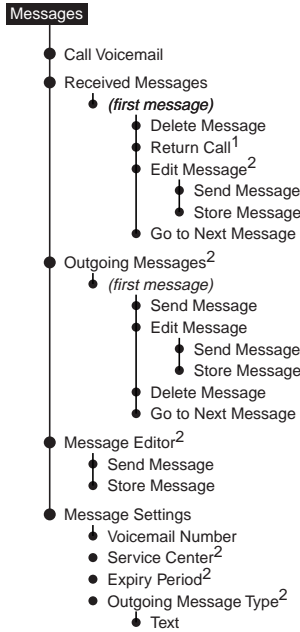

- 1 This feature is network and subscription dependent.
- 2 This feature is network and subscription dependent. It must be activated by your service provider.

Cellular Mode (GSM 900/1800) (GSM 900)

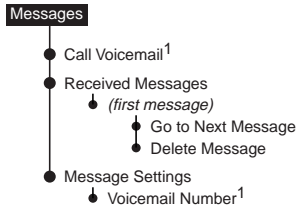



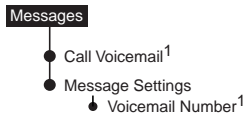

- 1 This feature is network and subscription dependent.

Cellular Mode (TDMA 800/1900) (CDMA 1900) (CDMA/AMPS)



- 1 This feature is network and subscription dependent.

Getting to Message Features...

1. Press  to go directly to the Messages menu.
or
Press  until you see Messages, and then press .
2. Press  to scroll to one of the features described below.

Checking Your Voicemail

This feature makes checking your voicemail simple.

1. **Follow the steps in** “Getting to Message Features...” to get to Call Voicemail.
2. Press  to select. You will see your voicemail number followed by Calling.

If you have not previously stored a voicemail number, then you will see *No Number Available*. See “Store Your Voicemail Number” on page 144 for instructions on how to enter a voicemail number.

Note: This feature is network and subscription dependent in cellular mode. Contact your service provider for additional information.

Managing Your Received Messages

How Your Phone Notifies You of Messages

If your phone is powered on, it notifies you of received messages in the following ways:

- **An alert sounds and/or the phone vibrates.**

Your phone beeps and/or vibrates three times to inform you of an incoming message. (See page 153 for instructions on how to set your phone's alert.)

- **The  (message) indicator is displayed.**
- **The message is displayed immediately** and remains on the display for several seconds.

or

Message Read Now? is displayed if the message is an alphanumeric text message of up to 160 characters. For more information see "Read a New Message" on page 132.

How Messages Are Stored

Your phone stores all messages on your SIM card. The total number of messages that you can store depends on your service provider.

If the message indicator is flashing, your SIM card is full. See "Delete a Message" on page 134 to make room for the new message.

What Messages Contain

You can receive short text or numeric messages in your Personal Mailbox. Text messages may contain up to 160 characters. Numeric messages—typically phone numbers—may contain up to 20 digits.

Your personal mailbox works along with call forwarding. For more information see “Personal Mailbox” on page 53, and the call forwarding feature descriptions on pages 108-115.

Messages contain multiple screens with the following information:

- the message
- the date and time the message was sent
- the phone number (if available) from which the message was sent

Accessing Received Messages



Satellite Mode
Cellular Mode
(GSM 900/1800)
(GSM 900)

Cellular Mode
(TDMA 800/1900)
(CDMA 1900)
(CDMA/AMPS)

Read a New Message





Notification Messages

An incoming voicemail notification message automatically scrolls across your screen. You can:

- Press  to store it on your SIM card.
- Press  to delete it.

Text Messages

When you receive a new alphanumeric message, you will see **Message Read Now?** To read it:







1. Press  and continue with **step 2.**
or
Press  to read the message later. See “Read a Stored Message” on page 133.
2. Press  to move forward through a message one screen at a time.
3. Press  to access menu options for the message. These options are described on pages 134-135.

Notes:

- If you are in cellular mode and you remove your GSM Cellular Cassette you will not be able to access your messages. Switch to satellite mode or reinsert your GSM cellular cassette.
- If the message storage space on your SIM card is full, you will not be able to store a message for later retrieval. Use the delete message feature (page 134) to make room for new messages on your SIM card.



This feature is not available in TDMA or CDMA cellular mode.

Getting to Received Messages...

1. Press  to go directly to the Messages menu.
or
Press  until you see Messages, and then press .
2. Press  to scroll to Received Messages, and then press .
3. Press  to scroll to one of the features described below.

Read a Stored Message

To read a stored message that you have received:

1. **Follow the steps in** “Getting to Received Messages...” to enter the message center. You will see the number of messages stored, followed by the first message. If you do not have any messages, you will see *No Messages*.
2. Press  to scroll through the message one screen at a time.
3. Press  to access menu options for the message.

or

Press and hold  to exit the menu.

This feature is not available in TDMA or CDMA cellular mode.

Satellite Mode
Cellular Mode
(GSM 900/1800)
(GSM 900)

Cellular Mode
(TDMA 800/1900)
(CDMA 1900)
(CDMA/AMPS)

Satellite Mode
Cellular Mode
(GSM 900/1800)
(GSM 900)

Cellular Mode
(TDMA 800/1900)
(CDMA 1900)
(CDMA/AMPS)

Satellite Mode
Cellular Mode
(GSM 900/1800)
(GSM 900)

Cellular Mode
(TDMA 800/1900)
(CDMA 1900)
(CDMA/AMPS)

Go to the Next Message





To go to the next message:

1. **Follow the steps** in “Read a Stored Message” on page 133.
2. **Press**  until you see **Go To Next Message** and then **press** . You will see the next message. If you are at the end of your message list you will see the first message again.
3. **Press**  to scroll through the message one screen at a time.
4. **Repeat steps 2 to 3** to read all of your messages.
5. **Press and hold**  to exit the menu.

This feature is not available in TDMA or CDMA cellular mode.

Delete a Message

Use this feature to make room for new messages on your SIM card.



1. **Follow the steps** in “Go to the Next Message” (above) until you see the message you want to delete, and then **press** .
2. **Press**  until you see **Delete Message**, and then **press** . You will see **Message Deleted**.
3. **Press and hold**  to exit the menu.

This feature is not available in TDMA or CDMA cellular mode.

Return a Call

A callback number appears in quotes within the received message. If one is enclosed, you can instantly place a call to that number. If a callback number is not included, your phone selects the first number in the message.



Note: You must subscribe to this network feature through your service provider. Contact your service provider for additional information.

1. **Follow the steps** in “Go to the Next Message” on page 134 to display the desired message, and then **press** .
2. **Press**  until you see Return Call.
3. **Press**  to place a call to that number. You will see the number followed by Call.

This feature is not available in cellular mode.

Edit a Stored Message

You can edit a message that you have received, then send the modified message and/or store it in the outgoing messages list.

1. **Follow the steps** in “Go to the Next Message” on page 134 until you see the message you want to edit, and then **press** .
2. **Press**  until you see Edit Message and then **press** .

The message is copied to the message editor. You will see the final portion of the message displayed in the editing area. The cursor is placed at the end of the message.

For instructions on how to edit a message, see “Message Editor” on page 136.

This feature is not available in cellular mode.





Satellite Mode

Cellular Mode

Satellite Mode

Cellular Mode

Getting to Message Features...

1. Press  to go directly to the Messages menu.
or
Press  until you see Messages, and then press .
2. Press  to scroll to one of the features described below.

Managing Outgoing Messages

Satellite Mode

You can create a new message and send it immediately, or store it in an outgoing messages list for later use. You can also edit a message that you have received, then send and/or save the modified message. Messages are created and edited in the message editor.

Message Editor

The message editor lets you create a new message or modify a stored message (received or outgoing).

You use the keypad to create or edit a message. You can produce any letter in the alphabet by pressing the appropriate key. For example, press  to enter the letters A, B, or C, as shown:

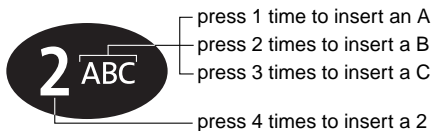

For a complete list of the characters you can enter from the keypad, see page 83.



Note: This feature must be activated by your service provider. Contact your service provider for additional information.

Create a New Message

To create a new message in the message editor:

1. **Follow the steps in** “Getting to Message Features...” to get to Message Editor, and then **press**  to select.

The message editor displays the contents of the last message entered. If there are no previous messages, the cursor is placed in the upper left corner of the editing area.

2. **Press and hold**  to clear the entire message editor contents, if necessary.
3. Begin composing your message. **Enter a letter** by pressing a key as many times as necessary.
4. **Press**  to advance the cursor.
5. **Repeat steps 3 and 4** as many times as necessary to complete your message.

Lines of text are automatically formatted in the display. When you reach the bottom of the editing area, the top lines of text scroll up and off the display in order to keep the cursor and the last few lines of text in view.

When you have finished composing your message:

6. **Press**  to access options for that entry.

Message editor menu options let you send the message immediately or store it for later use. These options are described on pages 138-139.



Tip: Press and hold any numeric key to toggle between uppercase and lowercase characters.

Edit a Message

You can edit a new message at any time while you are creating it.

You can also edit received messages or messages stored in the outgoing messages list. See “Edit a Stored Message” on page 135 for instructions on how to copy a received message into the message editor. See “Edit a Stored Message” on page 142 for instructions on how to copy an outgoing message into the message editor.

To **delete** text in a message:





1. **Press**  to scroll the cursor to the right of the text you want to delete.
2. **Press**  to delete one character at a time.
or
Press and hold  to clear the display.

To **add** text to a message:

1. **Press**  to scroll the cursor to the location where you want to add new text.
2. **Enter a letter** by pressing a key as many times as necessary.

Send a Message

To send a message from the message editor:

1. **Press**  to access message editor menu options.
2. **Press**  until you see **Send Message** and then **press** . You will be prompted to enter the destination address (phone number) for the message.
3. **Enter the destination address** and then **press**  to send the message.

The message is sent to your message service center, which forwards the message to its final destination. You will see **Message Sent** when the message arrives at the service center.

If the message cannot be delivered to the service center, you will see **Message Failed**, followed by **Resend?** on the next line. You can:

Press  to resend the message.



or

Press  to abandon the attempt to send the message at this time. See “Store a Message” on page 139 for instructions on how to store the message for later mailing.

If you have not previously stored a service center number, then you will see **No Service Center**. See “Enter Service Center Number” on page 145 for instructions on how to enter a service center number.

Store a Message

To store the contents of the message editor to the outgoing messages list:







1. **Press**  to access message editor menu options.
2. **Press**  until you see **Store Message** and then **press** . You will see **Stored to Outgoing**.

Outgoing messages are stored on your SIM card. When the SIM card is full (indicated by a flashing message indicator), you will not be able to store a message for later retrieval. Use the delete message feature (page 143) to make room for new messages on your SIM card.

The message editor is not available in cellular mode.

Cellular Mode

Getting to Outgoing Messages...



1. Press  to go directly to the Messages menu.
or
Press  until you see Messages, and then press .
2. Press  to scroll to Outgoing Messages, and then press .
3. Press  to scroll to one of the features described below.

Read a Stored Message

This feature displays the first message stored in the outgoing messages list.

Note: This feature must be activated by your service provider. Contact your service provider for additional information.

To read a stored message in satellite mode:

1. **Follow the steps in** “Getting to Outgoing Messages...” to enter the message center. You will see the number of messages stored, followed by the first message. If you do not have any messages, you will see *No Messages*.
2. Press  to scroll through the message one screen at a time.
3. Press  to access menu options for the message.

or

Press and hold  to exit the menu.

This feature is not available in cellular mode.

Satellite Mode



Cellular Mode

Go to the Next Message

This feature takes you to the next message in the outgoing messages list.

Note: This feature must be activated by your service provider. Contact your service provider for additional information.

To go to the next message in satellite mode:

1. **Follow the steps** in “Read a Stored Message” on page 140.
2. **Press**  until you see **Go To Next Message** and then **press** . You will see the next message.
3. **Press**  to scroll through the message one screen at a time.
4. **Repeat steps 2 to 3** to read all of your messages.
5. **Press and hold**  to exit the menu.



This feature is not available in cellular mode.

Send a Stored Message

This feature sends a message stored in the outgoing messages list.

Note: This feature must be activated by your service provider. Contact your service provider for additional information.

To send a stored message in satellite mode:

1. **Follow the steps in** “Read a Stored Message” on page 140.
2. **Press**  until you see **Send Message** and then **press** . You will be prompted to enter the destination address (phone number) for the message.

Satellite Mode

Cellular Mode

Satellite Mode

- 3. Enter the destination address** and then **press**  to send the message.

The message is sent to your message service center, which forwards the message to its final destination. You will see **Message Sent** when the message arrives at the service center.

If the message cannot be delivered to the service center, you will see **Message Failed**, followed by **Resend?** on the next line. You can:

Press  to resend the message.

or

Press  to abandon the attempt to send the message at this time.

If you have not previously stored a service center number, then you will see **No Service Center**. See “Enter Service Center Number” on page 145 for instructions on how to enter a service center number.

Cellular Mode

This feature is not available in cellular mode.



Edit a Stored Message

You can edit a message that you have stored in the outgoing messages list.

Note: This feature must be activated by your service provider. Contact your service provider for additional information.

Satellite Mode

To edit a stored message in satellite mode:

- 1. Follow the steps** in “Go to the Next Message” on page 141 until you see the message you want to edit, and then **press** .
- 2. Press**  until you see **Edit Message** and then **press** .

The message is copied to the message editor. You will see the final portion of the message displayed in the editing area. The cursor is placed at the end of the message.

For instructions on how to edit a message, see “Message Editor” on page 136.

This feature is not available in cellular mode.

Cellular Mode





Delete a Stored Message

Use this feature to make room for new messages on your SIM card.

Note: This feature must be activated by your service provider. Contact your service provider for additional information.

To delete a stored message in satellite mode:







Satellite Mode

1. **Follow the steps** in “Go to the Next Message” on page 141 until you see the message you want to delete, and then **press** .
2. **Press**  until you see Delete Message, and then **press** . You will see Message Deleted.
3. **Press and hold**  to exit the menu.

This feature is not available in cellular mode.

Cellular Mode

Getting to Message Settings...







1. Press  to go directly to the Messages menu.
or
Press  until you see Messages, and then press .
2. Press  to scroll to Message Settings, and then press .
3. Press  to scroll to one of the features described below.

Managing Other Message Settings

Tip: Use pause dialing to store your voicemail access and PIN numbers together. See “Using Pauses in Numbers” on page 84.

Store Your Voicemail Number

To store a voicemail number:

1. Follow the steps in “Getting to Message Settings...” to get to Voicemail Number, and then press  to select. You will see Enter Voicemail Number followed by your current voicemail number. If this is the first time you have stored a number, continue with **step 3**.
2. Press  to select Voicemail Number. Press  to clear one digit at a time, or press and hold  to erase the entire number.
3. Enter the new number, and then press . You will see Completed.
4. Press and hold  to exit the menu.





Note: This feature is network and subscription dependent in cellular mode. Contact your service provider for additional information.

Enter Service Center Number

Use this feature to enter the number for the service center that forwards your outgoing messages. You must specify a service number before you can send any messages.

Note: This feature must be activated by your service provider. Contact your service provider for additional information.

To enter the service center number in satellite mode:

- 1. Follow the steps in** “Getting to Message Settings...” to get to Service Centre, and then **press**  to select. You will see Enter Service Number followed by your current service center number. If this is the first time you have stored a number, continue with **step 3**.
- 2. Press**  to clear one digit at a time, **or press and hold**  to erase the entire number.
- 3. Enter the new number**, and then **press** . You will see Completed.
- 4. Press and hold**  to exit the menu.







This feature is not available in cellular mode.

Satellite Mode

Tip: *The service center number is normally provided by your service provider.*

Cellular Mode

Getting to Message Settings...

1. Press  to go directly to the Messages menu.
or
Press  until you see Messages, and then press .
2. Press  to scroll to Message Settings, and then press .
3. Press  to scroll to one of the features described below.

Satellite Mode

Tip: The default expiration period setting is 24 hours.





Cellular Mode

Set Expiry period

This feature specifies the maximum amount of time, in hours, that an unforwarded outgoing message will remain at the service center before it is deleted.

Note: This feature must be activated by your service provider. Contact your service provider for additional information.

To set the message expiration period in satellite mode:

1. **Follow the steps in** “Getting to Message Settings...” to get to **EXPIRY PERIOD**, and then press  to select. You will see **Enter Hours** followed by the current setting.
2. Press  to clear one digit at a time, **or press and hold**  to erase the entire number.
3. **Enter the new number**, and then press . You will see **Hours** followed by the number you entered.
4. **Press and hold**  to exit the menu.





This feature is not available in cellular mode.

Specify Outgoing Message Type

You can send messages to a device which interprets them in a format other than text. Your service center converts the messages before forwarding them to the destination address.

Note: This feature must be activated by your service provider. Contact your service provider for additional information.

To specify the outgoing message type in satellite mode:

1. **Follow the steps in** “Getting to Message Settings...” to get to **Outgoing Message Type**, and then **press**  to select.
2. **Press**  to scroll to the desired type, and then **press**  to select it.
3. **Press and hold**  to exit the menu.

This feature is not available in cellular mode.

Satellite Mode

Cellular Mode

Customizing Phone Features

Once you are comfortable with the basic features of your new phone, use the Phone Setup menu to configure your phone the way you like it.

The feature selection on the Phone Setup menu varies depending on your mode setting. The table below shows the features available in each mode. See “Selecting a Mode” on page 185 for more information on changing modes.

Feature	Satellite	GSM	TDMA 800/1900	CDMA 1900	CDMA/ AMPS
Emergency Number: Set			•	•	•
Extended Menus: Activate	•	•	•	•	•
Infrared Data Port: Activate	•				
International Dialing Prefix: Set			•	•	•
Keypad Tones: Normal/Single/Off	•	•	•	•	•
Language Selection	•	•	•	•	•
Lights: On/Off	•	•	•	•	•
Phone Lock: Automatic/Now/ Change Unlock Code	•	•	•	•	•
Phone Lock: Unlock Phone (non-menu item)	•	•	•	•	•
Phone Number: Change			•	•	•
Phone Status: Review/ Master Reset/Master Clear	•				
Ring or Vibrate: Ring Only/ Vibrate Only/Vibrate Then Ring/Off	•	•	•	•	•
Ringer Tone: Set	•	•	•	•	•
Ringer Volume: Adjust	•	•	•	•	•
Security Code: Change	•	•	•	•	•
SIM Card PIN Code: Activate/Change	•	•	•	•	•
SIM Card PIN Code: Unblock (non-menu item)	•	•	•	•	•
SIM Card PIN2 Code: Change	•	•	•	•	•
SIM Card PIN2 Code: Unblock (non-menu item)	•	•	•	•	•
System Scan Mode: Select			•		•
Time and Date: Set Home/Set Away	•	•	•	•	•
Time and Date: Show Home/Show Away/Change	•	•	•	•	•
Time Format: 12-Hour/24-Hour	•	•	•	•	•

Phone Setup Menu

Satellite Mode

Phone Setup

- Adjust Ring Volume
- Ring or Vibrate
 - Ring Only
 - Vibrate Only
 - Vibrate Then Ring
 - No Ring or Vibrate
- Set Ringer Tone
 - Standard Tone
 - ⋮
 - High Tone
- Phone Lock
 - Automatic Lock
 - On/Off
 - Lock Now
 - Change Unlock Code
- Activate IR Port
- Require SIM Card PIN
 - On/Off
 - Change SIM PIN Code
- Change SIM PIN2 Code
- New Security Code
- Extended Menus
 - On/Off

The following Phone Setup menu items are available only when the extended menus are activated.

- Show Time and Date¹
 - Show Home Time + Date
 - Show Away Time + Date
 - Change Clock Display
 - Home Time
 - Away Time
- Set Time and Date¹
 - Set Home Time + Date
 - Set Away Time + Date
- Set Time Format¹
 - 12 Hour
 - 24 Hour
- Language Selection¹
 - English
 - ⋮
 - Türkçe
- Lights¹
 - On/Off
- Select Keypad Tones¹
 - Normal Tones
 - Single Tone
 - No Tones
- Phone Status¹
 - Status Review
 - Master Reset
 - Master Clear

¹ This feature is available only when the extended menus are activated.

Phone Setup

- Emergency Mapping¹
- Intl Dialing Prefix¹
- Change Number¹
- System Scan²
 - Std A/B
 - Scan B/A
 - Std B/A
 - Scan A/B
 - Scan A
 - Scan B
 - Home Only
 - Preferred SIDs
- System Options¹
 - Display SID
 - Roam List Version³
- Adjust Ring Volume
- Ring or Vibrate
 - Ring Only
 - Vibrate Only
 - Vibrate Then Ring
 - No Ring or Vibrate
- Set Ringer Tone
 - Standard Tone
 - High Tone
- Phone Lock
 - Automatic Lock
 - On/Off
 - Lock Now
 - Change Unlock Code
- Require SIM Card PIN
 - On/Off
 - Change SIM PIN Code
- Change SIM PIN2 Code
- New Security Code
- Extended Menus
 - On/Off

Cellular Mode

The following Phone Setup menu items are available only when the extended menus are activated.

- Show Time and Date⁴
 - Show Home Time + Date
 - Show Away Time + Date
 - Change Clock Display
 - Home Time
 - Away Time
- Set Time and Date⁴
 - Set Home Time + Date
 - Set Away Time + Date
- Set Time Format⁴
 - 12 Hour
 - 24 Hour
- Language Selection⁴
 - English
 - Türkçe
- Lights⁴
 - On/Off
- Select Keypad Tones⁴
 - Normal Tones
 - Single Tone
 - No Tones



1 This feature is available only in TDMA 800/1900, CDMA 1900, or CDMA/AMPS cellular mode.

2 This feature is available only in CDMA/AMPS cellular mode.

3 This feature is available only in CDMA 1900 cellular mode.

4 This feature is available only when the extended menus are activated.

Getting to Phone Setup...



1. Press  until you see Phone Setup, and then press .
2. Press  to scroll to one of the features described below.

Managing Phone Ringer Settings

You can adjust your phone's ringer volume and tone, and set the phone to ring or vibrate to notify you of incoming calls.

Adjust the Ringer Volume





Use this feature to adjust the volume of the ringer. The phone sounds the new volume level as you adjust it.

1. **Follow the steps in** "Getting to Phone Setup..." to get to Adjust Ring Volume, and then press  to select.
2. **Increase the volume** by pressing the upper volume control key.
or
Decrease the volume by pressing the lower volume control key.
3. **Press and hold**  to exit the menu.

Tip: You can also press , and then the up or down volume control key.





Set the Phone to Ring or Vibrate

This feature is ideal for situations where a ringing phone is inappropriate or in noisy places where you might not hear the ringer. The VibraCall® alert function notifies you of incoming calls by discreet vibrations.

1. **Follow the steps in** “Getting to Phone Setup...” to get to Ring or Vibrate, and then **press**  to select.
2. **Press**  to scroll to Ring Only, Vibrate Only, Vibrate then Ring, or No Ring or Vibrate, and then **press**  to select the displayed option. You will see Completed.
3. **Press and hold**  to exit the menu.





Set the Ringer Tone

Select your favorite tone from 10 different options.

1. **Follow the steps in** “Getting to Phone Setup...” to get to Set Ringer Tone, and then **press**  to select.
2. **Press**  to scroll through the ringer tone options. You will hear a one-ring-cycle demonstration of each tone as its name is displayed.
3. **Press**  to select the desired ringer tone.
4. **Press and hold**  to exit the menu.

Tip: *If you select Vibrate then Ring, your phone vibrates for two cycles, and then rings.*

Getting to Phone Lock...





1. Press  until you see Phone Setup, and then press .
2. Press  to scroll to Phone Lock, and then press .
3. Press  to scroll to one of the features described below.

Locking and Unlocking Your Phone

These features can help you prevent unwanted use of your phone.

Lock the Phone Automatically

Use this feature to set your phone to lock itself every time it is powered on.

1. **Follow the steps in** “Getting to Phone Lock...” to get to Automatic Lock, and then press  to select.
2. Press  to choose On or Off, and then press  to select. You will see Completed.
3. Press and hold  to exit the menu.

Lock the Phone Instantly

Use this feature to lock your phone immediately.

1. **Follow the steps in** “Getting to Phone Lock...” to get to Lock Now.
2. Press  to select. You will see: Locked.

Note: Once you unlock your phone, it remains unlocked until you lock it again.





Unlock the Phone

1. **Enter unlock code.** Enter your four-digit phone unlock code.
2. Press .

Tip: The factory default unlock code is 1234.



Change the Unlock Code

The unlock code is originally set to 1234. You should change it as soon as possible.

1. **Follow the steps in** “Getting to Phone Lock...” to get to **Change Unlock Code**, and then **press**  to select. You will see **Enter Security Code**.
2. **Enter security code.** Enter your six-digit security code. You will see your current lock code and **Enter Phone Unlock Code**.
3. **Press**  to clear one digit at a time, **or press and hold**  to clear all the digits.
4. **Enter new code.** Enter a new four-digit unlock code, and then **press** . You will see **Phone Lock** and the new lock code.
5. **Press and hold**  to exit the menu.



Tip: *The factory default security code is 000000.*

Getting to Phone Setup...

1. Press  until you see Phone Setup, and then press .
2. Press  to scroll to one of the features described below.

Activating the Infrared Data Port

Use this feature to activate the infrared data port on your phone when you want to establish a wireless infrared connection with an external device.

1. **Follow the steps in** "Getting to Phone Setup..." to get to Activate IR Port, and then press  to select. You will see Activating Cancel?.
2. **Align your phone** so that the infrared data port on the phone is in direct line of sight with the infrared data port on the external device. Make sure that both infrared data ports are within their effective range. You will see Activated when the connection is established.
3. **Press and hold**  to exit the menu.





Your phone waits for an infrared connection for up to five minutes. If an infrared connection cannot be established, and your phone is running on battery power, the phone then deactivates the infrared data port. Before deactivating, your phone emits an alert tone and displays Reactivate IR Port for ten seconds. Press  when you see this message to reactivate the infrared data port.

If you move your phone out of effective range for more than one minute when an infrared connection has been established, you will see Connection Lost.

For instructions on using TrueSync to exchange contact information with your computer, please refer to the TrueSync User's Guide.

Note: This feature will be available in the first quarter of 2000.

Getting to Require SIM Card PIN...



1. Press  until you see Phone Setup, and then press .
2. Press  to scroll to Require SIM Card PIN, and then press .
3. Press  to scroll to one of the features described below.

Protecting the SIM Card

You can use a Personal Identification Number (PIN) code to protect the information stored on your SIM card even when it is inserted into someone else's phone.





Activate and Deactivate the SIM Card PIN Code

When you activate the SIM card PIN code, your phone requests the code whenever the phone is powered on. To change this setting, you need to enter the PIN code that your service provider gave you.

1. **Follow the steps in** “Getting to Require SIM Card PIN...” to scroll to On or Off, and then press  to select. You will see Enter PIN.
2. **Enter code.** Enter your four- to eight-digit SIM card PIN code, and then press . You will see Completed.
3. **Press and hold**  to exit the menu.





Tip: You should have received your SIM card PIN code from your service provider.

Getting to Require SIM Card PIN...

1. Press  until you see Phone Setup, and then press .
2. Press  to scroll to Require SIM Card PIN, and then press .
3. Press  to scroll to one of the features described below.









Change the SIM Card PIN Code

To choose your own PIN code:

1. **Follow the steps in** “Getting to Require SIM Card PIN...” to get to Change SIM Card PIN, and then press  to select. You will see Enter Old PIN.
2. **Enter the current PIN code**, and then press . You will see Enter New PIN.
3. **Enter a new PIN code**, and then press . You will see Repeat New PIN.
4. **Re-enter the new PIN code**, and then press  again. You will see Completed.
5. **Press and hold**  to exit the menu.



Unblock the PIN Code

If your PIN code is entered incorrectly three times in a row, Blocked appears in the display. You need to enter a PIN unblocking key (PUK1), which you can obtain from your service provider.

1. Press     .
2. **Enter unblocking key.** Enter the eight-digit PUK1 unblocking key, and then press . Your service provider supplies this code.
3. **Enter a new PIN code**, and then press .
4. **Re-enter the new PIN code**, and then press .

Tip: The message Blocked indicates that an incorrect PIN code was entered. The message  Blocked indicates that an incorrect PIN2 code was entered.

Getting to Phone Setup...

1. Press  until you see Phone Setup, and then press .
2. Press  to scroll to one of the features described below.





Managing Other Security Settings

Your phone includes other security features:

- a SIM card PIN2 code for accessing fixed dialing settings and other subscription-dependent features
- a security code controls access to security and other menu options



Change the SIM Card PIN2 Code

Your SIM card PIN2 code is used to access fixed dialing settings. This four- to eight-digit code is issued to you when you subscribe to the feature. Use this feature to choose a new code.

1. **Follow the steps in** “Getting to Phone Setup...” to get to **Change SIM PIN2 Code**, and then press  to select. You will see **Enter Old PIN2**.
2. **Enter the current PIN2 code**, and then press . You will see **Enter New PIN2**.
3. **Enter new PIN2 code**, and then press . You will see **Repeat New PIN**.
4. **Re-enter the new PIN2 code**, and then press  again. You will see **Completed**.
5. **Press and hold**  to exit the menu.









Tip: You should have received your SIM card PIN2 code from your service provider.

Getting to Phone Setup...

1. Press  until you see Phone Setup, and then press .
2. Press  to scroll to one of the features described below.





Unlock the PIN2 Code

If your PIN2 code is entered incorrectly three times in a row,  Blocked appears in the display. You need to enter a PIN2 unblocking key (PUK2), which you can obtain from your service provider.

1. Press      .
2. **Enter unblocking key.** Enter the eight-digit PUK2 unblocking key, and then press . Your service provider supplies this code.
3. **Enter a new PIN2 code**, and then press .
4. **Re-enter the new PIN2 code**, and then press .





Change the Security Code

The security code is your phone's primary security number. You use it to reset your phone to its default settings and prevent access to your phone book. It is originally set to 000000.

1. **Follow the steps in** "Getting to Phone Setup..." to get to **New Security Code**, and then press  to select. You will see **Enter Security Code**.
2. **Enter the current security code**, and then press . You will see **Enter New Security Code**.
3. **Enter a new security code**, and then press . You will see **Secur. Code** and the six-digit number selected.
4. **Press and hold**  to exit the menu.



Activating Extended Menus

This feature activates and deactivates the extended menus. See “Personalizing the Options Menu” on page 200 to learn how extended menus can make your phone even simpler to use.

1. **Follow the steps in** “Getting to Phone Setup...” to get to **Extended Menus**, and then **press**  to select.
2. **Press**  to choose **On** or **Off**, and then **press** .
3. **Press and hold**  to exit the menu.

When extended menus are deactivated, you can activate them temporarily to access hidden features. Press and hold  to activate the extended menus temporarily. This shortcut displays all extended menu features until you exit the Options menu.

Getting to Phone Setup...





1. Press  until you see Phone Setup, and then press .
2. Press  to scroll to one of the features described below.

Managing Time and Date Settings

View the Time and Date

Use this feature to view the current time and date in one of two time zones.







Note: This feature is available only when the extended menus are activated. See “Activating Extended Menus” on page 161.

1. **Follow the steps in** “Getting to Phone Setup...” to get to Show Time and Date, and then press  to select.
2. Press  to choose Show Home Time + Date or Show Away Time + Date, and then press . The selected time and date are displayed.
3. Press **any key** to clear the time and date from the display and return to the menu.
4. Press and hold  to exit the menu.

Change the Time Displayed

Use this feature to determine which time is displayed on your real time clock indicator.





Note: This feature is available only when the extended menus are activated. See “Activating Extended Menus” on page 161.

1. **Follow the steps in** “Getting to Phone Setup...” to get to Show Time and Date, and then **press**  to select.
2. **Press**  to scroll to Change Clock, and then **press** .
3. **Press**  to scroll to either Home Time or Away Time, and then **press** .
4. **Press and hold**  to exit the menu.



Set the Time Format

You can choose a 12-hour or 24-hour time format.

Note: This feature is available only when the extended menus are activated. See “Activating Extended Menus” on page 161.

1. **Follow the steps in** “Getting to Phone Setup...” to get to Set Time Format, and then **press** .
2. **Press**  to choose either 12-hour or 24-hour, and then **press** .
3. **Press and hold**  to exit the menu.

Getting to Phone Setup...









1. Press  until you see Phone Setup, and then press .
2. Press  to scroll to one of the features described below.

Tip: *The time displayed (home or away) on the real time clock indicator is the one you selected on page 163.*

Set the Time and Date

To make it easy to check the local time when you travel, your phone can save the current time and date for two different time zones.





Note: This feature is available only when the extended menus are activated. See “Activating Extended Menu” on page 161.





1. **Follow the steps in** “Getting to Phone Setup...” to get to Set Time and Date, and then press  to select.
2. Press  to choose Set Home Time + Date or Set Away Time + Date, and then press . You will see Enter Time and the time currently set.
3. Press  to accept the displayed time.
or
Enter the time in 24-hour format, and then press . You will see Enter Date and the date currently set.
4. Press  to accept the displayed date. You will see Completed.
or
Enter the date in day(dd)-month(mm)-year(yy) form and then press . You will see Completed.
5. **Press and hold**  to exit the menu.

Selecting the Display Language



Your phone contains 21 languages. Use this feature to select the language in which your phone displays menus and messages.

Note: This feature is available only when the extended menus are activated. See “Activating Extended Menus” on page 161.

1. **Follow the steps in** “Getting to Phone Setup...” to get to Language Selection, and then **press**  to select.
2. **Press**  to scroll through the choices, and then **press**  to select the displayed option.
3. **Press and hold**  to exit the menu.

If you accidentally change the language of your phone’s display, press and hold the  key to return to the idle display, then press     to return directly to the language selection submenu.





Getting to Phone Setup...

1. Press  until you see Phone Setup, and then **press** .
2. Press  to scroll to one of the features described below.

Turning Lights On and Off

You can activate or deactivate all phone lighting, including the phone status indicator, display backlighting, and keypad backlighting.





Note: This feature is available only when the extended menus are activated. See “Activating Extended Menus” on page 161.

1. **Follow the steps in** “Getting to Phone Setup...” to get to **Lights**, and then **press**  to select.
2. Press  to choose **On** or **Off**, and then **press**  to select the displayed option.
3. **Press and hold**  to exit the menu.





Setting Keypad Tones

Choose the sounds your phone makes when its keys are pressed.

Note: This feature is available only when the extended menus are activated. See “Activating Extended Menus” on page 161.

1. **Follow the steps in** “Getting to Phone Setup...” to get to **Select Keypad Tones**, and then **press**  to select.
2. **Press**  to choose **Normal Tones**, **Single Tone**, or **No Tones**, and then **press** .
3. **Press and hold**  to exit the menu.

Getting to Phone Status...



1. Press  until you see Phone Setup, and then press .
2. Press  to scroll to Phone Status, and then press .
3. Press  to scroll to one of the features described below.

Managing Phone Settings

Review Your Phone's Settings

Use this feature to review all of your phone's settings that have changed from their original default settings.

To review all settings:

1. **Follow the steps in** "Getting to Phone Status..." to get to Status Review, and then press  to select.
2. Press  to scroll through the list of all the menu items you have changed.
3. **Press and hold**  to exit the menu.

Note: You can reset your phone's original settings if desired. See "Reset Phone Options to Factory Defaults" on page 169.

Satellite Mode

Cellular Mode



This feature is not available in cellular mode.

Reset Phone Options to Factory Defaults

Use the master reset feature to reset all settings to their original default settings. This feature:

- resets audible call timers, the in-call timer, and the automatic lock
- resets extended menus to default setting
- restores keypad tones to normal, ringer tone to standard, and the volume level to the middle (fourth bar) of its range
- resets cellular mode (TDMA and CDMA) emergency number and international dialing prefix
- resets the mode selection (this may cause your phone to switch modes)

To reset all settings:

1. **Follow the steps in** “Getting to Phone Status...” to get to **Master Reset**, and then **press**  to select. You will see **Enter Security Code**.
2. **Enter your six-digit security code**. You will see **Reset Complete**.
3. **Press and hold**  to exit the menu.





This feature is not available in cellular mode. However, when you reset your settings from satellite mode, your cellular settings are reset as well.

Satellite Mode

Tip: The factory default security code is 000000.

Cellular Mode

Getting to Phone Status...

1. Press  until you see Phone Setup, and then press .
2. Press  to scroll to Phone Status, and then press .
3. Press  to scroll to one of the features described below.

Clear All Stored Information



The master clear feature resets the same items as master reset, plus the following:

- clear phone book entries from phone memory (not from SIM memory)
- clear last ten calls made and received lists
- reset resettable call timers

Master clear does not clear the:

- fixed dial list
- my number(s) list
- received messages list

To clear all settings:

1. **Follow the steps in** “Getting to Phone Status...” to get to Master Clear, and then press  to select. You will see Enter Security Code.
2. **Enter your six-digit security code.** You will see Reset Complete.
3. **Press and hold**  to exit the menu.



This feature is not available in cellular mode. However, when you clear your settings from satellite mode, your cellular settings are cleared as well.

Satellite Mode

Tip: The factory default security code is 000000.

Cellular Mode

Getting to Phone Setup...

1. Press  until you see Phone Setup, and then press .
2. Press  to scroll to one of the features described below.



Cellular Mode Settings

These phone setup features are available in TDMA and CDMA cellular modes only. For information on switching to cellular mode, see “Selecting a Mode” on page 185.

Set Up the Emergency Number

This feature is not available in satellite mode or GSM cellular mode.



This feature allows you to dial 112 to make an emergency call even if your local emergency number is not 112. The default number is 911.

1. **Follow the steps in** “Getting to Phone Setup...” to get to Emergency Mapping, and then press  to select. You will see Enter Number?
2. **Enter number.** Enter your local emergency number and then press .
3. **Press and hold**  to exit the menu.

Satellite Mode
Cellular Mode
(GSM 900/1800)
(GSM 900)

Cellular Mode
(TDMA 800/1900)
(CDMA 1900)
(CDMA/AMPS)

Getting to Phone Setup...

1. Press  until you see Phone Setup, and then press .
2. Press  to scroll to one of the features described below.



Satellite Mode
Cellular Mode
(GSM 900/1800)
(GSM 900)

Cellular Mode
(TDMA 800/1900)
(CDMA 1900)
(CDMA/AMPS)

Set Up an International Prefix

This feature is not available in satellite mode or GSM cellular mode.

This feature allows you to use the  key (international dialing prefix +) to make an international call without entering the access code for the country, no matter what mode you are in. The default prefix is 001.

1. **Follow the steps in** “Getting to Phone Setup...” to get to Intl Dialing Prefix, and then press  to select. You will see Enter Number?.
2. **Enter number.** Enter the international access code for the country you are in, and then press .
3. **Press and hold**  to exit the menu.



Set System Scan Preference

This feature is not available in satellite mode, GSM cellular mode, TDMA cellular mode, or CDMA 1900 cellular mode.

The system scan feature lets you select the type of cellular system your phone accesses. This feature typically is configured by your cellular service provider.

Select a System Scan Method

The display shows *Analog* when you are registered with an analog system, or *Digital* when you are registered with a digital system.

1. **Follow the steps in** “Getting to Phone Setup...” to get to *System Scan*, and then **press**  to select.
2. **Press**  to scroll to *Std A/B*, *Scan A/B*, *Std B/A*, *Scan B/A*, *Scan A*, *Scan B*, *Home Only*, or *Preferred SIDs*, and then **press**  to select.

See the table on page 174 for a description of these system scan settings.

3. **Press and hold**  to exit the menu.

Satellite Mode

Cellular Mode

(GSM 900/1800)

(GSM 900)

(TDMA 800/1900)

(CDMA 1900)



Cellular Mode

(CDMA/AMPS)

System Scan Settings

Setting	Description
Standard Mode	Your phone first seeks a home type system, then a non-home type system. <ul style="list-style-type: none">• If home system is non-wireline (type A), you will see <i>Std A/B</i>.• If home system is wireline (type B), you will see <i>Std B/A</i>.
Reversed Preference Mode	Your phone first seeks a non-home type system, then a home type system. (This mode may be useful in fringe areas or certain roaming situations.) <ul style="list-style-type: none">• If home system is non-wireline (type A), you will see <i>Scan B/A</i>.• If home system is wireline (type B), you will see <i>Scan A/B</i>.
Home Only Mode	Your phone does not operate outside its home system. You see will <i>Home Only</i> .
Scan A Mode	Your phone operates only within non-wireline (A) systems. You will see <i>Scan A</i> .
Scan B Mode	Your phone operates only within wireline (B) systems. You will see <i>Scan B</i> .
Enhanced Preferred Scanning Mode	Your phone scans for home or programmed preferred System ID numbers (SIDs) first. This mode requires entry of the SIDs for the systems in which you wish to operate. Contact your cellular service provider for SID information. If you have selected two system operation, the phone seeks cellular service according to the system type mode selected for each phone number. You will see <i>Preferred SIDs</i> .

Getting to Phone Setup...





1. Press  until you see Phone Setup, and then press .
2. Press  to scroll to one of the features described below.

Switch Phone Numbers

This feature is not available in satellite mode or GSM cellular mode.

Your phone can operate on two to four different home systems depending on your Cellular Cassette. This feature lets you change your active number to the one appropriate for your current area. All the phone numbers are designated as your home system, but only one number can be active at any given time. Calls are placed and received by the currently active number only.

To change the active phone number:

1. **Follow the steps in** “Getting to Phone Setup...” to get to Change Number, and then **press**  to select. You will see your active number with a ✓ next to it.
2. **Press**  to scroll through your phone numbers and **press**  to switch to that phone number.
Note: Contact your service provider to add additional numbers to this list.
3. **Press**  to confirm the new setting. You will see Set.
4. **Press and hold**  to exit the menu.

Satellite Mode
Cellular Mode
(GSM 900/1800)
(GSM 900)

Cellular Mode
(TDMA 800/1900)
(CDMA 1900)
(CDMA/AMPS)

Accessing the Network

This chapter shows you how to register with the Iridium® satellite network in satellite mode, or how to locate and register with an available local network in GSM cellular mode.

The feature selection on the Network Selection menu varies depending on your mode setting. The table below shows the features available in each mode. See “Selecting a Mode” on page 185 for more information on changing modes.

Feature	Satellite	GSM 900/ 1800	GSM 900	TDMA 800/1900	CDMA 1900	CDMA/ AMPS
Available Networks: Register Now		•	•			
Find New Network		•	•			
Network Search: Automatic/Manual		•	•			
Register Now	•	•	•			

Network Selection Menu

Satellite Mode

Network Selection

- Register Now

Cellular Mode (GSM 900/1800) (GSM 900)



Network Selection

- Available Networks
 - Register Now
- Network Search
 - Registration Preferences
 - Automatic Search
 - Manual Search
- Find New Network

Cellular Mode (TDMA 800/1900) (CDMA 1900) (CDMA/AMPS)

This menu is not available in TDMA or CDMA cellular mode.

Getting to Network Selection...

1. Press  until you see *Network Selection*, and then press .
2. Press  to scroll to one of the features described below.

Registering With the Satellite Network

Use this feature to access Iridium satellite service. Your phone searches for the Iridium satellite network.

1. **Rotate and extend the antenna** upward. See “Holding the Phone” on page 44.
2. **Follow the steps in** “Getting to Network Selection...” to get to *Register Now*.
3. **Press**  to select. You will see *Registering....* This may take a few seconds.

If the phone finds the signal, you will see *Registered* and the signal strength indicator:



The  (home system) indicator also appears.

If the phone is unsuccessful you may see one of these messages: *Rotate and Extend Antenna*, *Check Signal*, *Busy Try Later*, *Please Try Later*, or *Restricted Area*.



Note: You must wait three minutes between registration attempts.

This feature is not available in cellular mode.

Satellite Mode

Cellular Mode

Getting to Network Selection...

1. Press  until you see *Network Selection*, and then press .
2. Press  to scroll to one of the features described below. You will see the feature name, followed by *Select?*.

Cellular Mode Settings

Satellite Mode

Cellular Mode (GSM 900/1800) (GSM 900)





Cellular Mode (TDMA 800/1900) (CDMA 1900) (CDMA/AMPS)



These network selection features are available in GSM cellular mode only. For information on switching to cellular mode, see “Selecting a Mode” on page 185.

Scanning for Available Networks

This feature is not available in satellite mode.

This option scans to see which networks are operating in your current location.

1. **Follow the steps in** “Getting to Network Selection...” to get to *Available Networks*, and then press . You will see *Scanning* and then a list of the available networks.
2. Press  to scroll to the network you want to register with, and then press . You will see *Register Now?*.
3. Press  to register with the network. You will see *Searching*.

When your phone has completed registering with the network, you will see the name of the network and either the  (home system) or  (roam) indicator.

This feature is not available in TDMA or CDMA cellular mode.

Setting Network Search Method





This feature is not available in satellite mode.

When your phone needs to register with a network, it generates a sorted list of networks. The network list is sorted in the following order:

- the home network
- networks from a preferred list
- random list of other networks found above a certain signal strength
- remaining networks in descending order of signal strength

Any forbidden networks stored in the SIM card are not included in the sorted list. The feature allows you to determine how the phone tries to register with a system. See the table on page 182 for a description of the available search methods.







To set your network search method:

1. **Follow the steps in** “Getting to Network Selection...” to get to Network Search, and then **press** . You will see Registration Preferences.
2. **Press** .
3. **Press**  to scroll to Automatic Search or Manual Search, and then **press** . You will see Completed.

Satellite Mode

Cellular Mode
(GSM 900/1800)
(GSM 900)



You can select one of the following search methods:

Method	Description
Automatic Search	The phone tries to register with the first network in the sorted list that satisfies the GSM network search rules described on page 181. If this is successful your phone displays the network name.
Manual Search	<p>The phone shows a sorted list of networks within range. You select the network with which you want to register. You will see Search Network followed by Search?</p> <ol style="list-style-type: none">1. Press  to generate the sorted list.2. Press  to select the network you want to register with, and then press . You will see Register Now?.3. Press  to register with that network. <p>When your phone has completed registering with the network, you will see the name of the network and the  or  indicator.</p>

Cellular Mode
(TDMA 800/1900)
(CDMA 1900)
(CDMA/AMPS)

This feature is not available in TDMA or CDMA cellular mode.

Getting to Network Selection...

1. Press  until you see Network Selection, and then press .
2. Press  to scroll to one of the features described below. You will see the feature name, followed by Select?.

Finding a New Network



This feature is not available in satellite mode.

When your phone tries to register with a network, it excludes your current network from the search. If the attempt fails, your phone then attempts to re-register with the previous network.

1. Follow the steps in “Getting to Network Selection...” to get to Find New Network, and then press .

If you are using the automatic search method (described on page 182), you will see Searching and then the name of the network.

If you are using the manual search method (described on page 182), continue with **step 2**.

2. Press  to scroll to the network you want to register with, and then press . You will see Searching and then the name of the network.

This feature is not available in TDMA or CDMA cellular mode.

Satellite Mode

Cellular Mode
(GSM 900/1800)
(GSM 900)

Cellular Mode
(TDMA 800/1900)
(CDMA 1900)
(CDMA/AMPS)

Selecting a Mode

If you have an optional Cellular Cassette installed in your satellite phone, you can access the cellular network as well as the satellite network. This chapter shows you how to select the type of service you want to use, and how to set your mode selection preferences on the Mode Selection menu.

The table below shows the features available on the Mode Selection menu.

Feature	Satellite	GSM 900/ 1800	GSM 900	TDMA 800/1900	CDMA 1900	CDMA/ AMPS
Cellular Always	•	•	•	•	•	•
Cellular Preferred	•	•	•	•	•	•
Satellite Always	•	•	•	•	•	•
Satellite Preferred	•	• ¹	• ¹	•	•	•

¹ This feature may not be available for some GSM Cellular Cassette users. Check with your service provider.

Mode Selection Menu

All Modes

Mode Selection

- Cellular Preferred
- Cellular Always
- Satellite Preferred
- Satellite Always

Phone Behavior by Mode

Preferred (Automatic) Modes



When you select a preferred mode, your phone looks for that type of service first. If it cannot find your preferred service, after about five minutes, it switches automatically to your non-preferred service. If the phone switches to a non-preferred service, it checks at regular intervals (every 30 minutes) to see if your preferred service has become available. The exact intervals that your phone switches modes and checks for preferred service varies depending on your SIM card. Check with your service provider.

Note: The phone postpones a switch between modes while you are in a call or are actively using one of the phone's features.

Always (Manual) Modes

If you select an always mode, your phone always accesses that type of service. If you become out-of-range in that mode, the phone does not switch to the other type of service. You have to manually switch it to the other mode by changing the settings in this menu.

Getting to Mode Selection...

1. Press  until you see Mode Selection, and then press .
2. Press  to scroll to one of the features described below. You will see the feature name, followed by Select?.

Selecting Satellite Mode

Select Satellite Preferred Mode

When you select this feature, your phone uses your Iridium satellite service if possible. When you are in satellite mode, you will see the  (satellite mode) indicator in the lower left corner of your display.

If you are out of range and are unable to access a satellite, your phone switches automatically to cellular mode. If this happens, you no longer will see the  indicator in the lower left corner of your display.

1. Follow the steps in “Getting to Mode Selection...” to get to Satellite Preferred.

2. Press  to select.

If you see the message Check Cassette or Insert Cassette, make sure your cassette is installed and is installed properly.

3. Press and hold  to exit the menu.

Note: This feature may not be available for some GSM Cellular Cassette users. If you power up your phone with a GSM Cellular Cassette inserted, your phone may switch to Cellular Preferred mode.



Tip: You must have a Cellular Cassette installed in your phone for this selection to work properly.

Select Satellite Always Mode

When you select this feature, your system always accesses the Iridium satellite network. When you are in satellite mode, you will see the  (satellite mode) indicator in the lower left corner of your display.

1. **Follow the steps in** “Getting to Mode Selection...” to get to **Satellite Always**.
2. **Press**  to select.

Getting to Mode Selection...

1. Press  until you see Mode Selection, and then press .
2. Press  to scroll to one of the features described below. You will see the feature name, followed by Select?.

Selecting Cellular Mode

Select Cellular Preferred Mode

When this mode is active, your phone uses your cellular service if possible. If you are out of range, your phone switches to satellite mode. If this happens, you will see the  (satellite mode) indicator in the lower left corner of your display.

1. Follow the steps in “Getting to Mode Selection...” to get to Cellular Preferred.
2. Press  to select.

If you see the message Check Cassette or Insert Cassette, make sure your Cellular Cassette is installed properly.

Select Cellular Always Mode

When you select this feature, your system always accesses the cellular network.

1. Follow the steps in “Getting to Mode Selection...” to get to Cellular Always.
2. Press  to select.

If you see the message Check Cassette or Insert Cassette, make sure your Cellular Cassette is installed properly.

Tip: You must have a Cellular Cassette installed in your phone for these selections to work properly.

Timing Your Calls

Your phone's call meters give you a variety of options for tracking the time you spend on the phone. You can monitor the length of individual calls, set a timer to track monthly usage, or have the phone alert you with tones at specific intervals.

Note: The features described in this chapter are only available in satellite mode.

The table below shows the features available on the Call Meters menu. The Call Meters menu is only available in satellite mode. See “Selecting a Mode” on page 185 for more information on changing modes.

Feature	Satellite	GSM 900/ 1800	GSM 900	TDMA 800/1900	CDMA 1900	CDMA/ AMPS
In-Call Display: Show/No Display	•					
Lifetime Timer	•					
Set Audible Call Timers: Repetitive/Single Alert	•					
Show Call Timers: Last Call/Total/Reset All	•					

Call Meters Menu

Satellite Mode

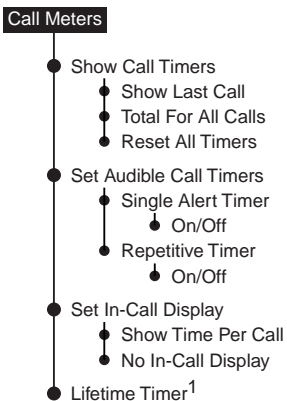





1 This feature is available only when the extended menus are activated.

Cellular Mode

This menu is not available in cellular mode.

Getting to Show Call Timers...

1. Press  until you see Call Timers, and then press .
2. Press  to scroll to Show Call Timers, and then press .
3. Press  to scroll to one of the features described below.

Showing Call Timers

Call timers help you track your airtime. Keep a running tab of your monthly usage or view the airtime of your most recent call.

Show the Time of the Last Call

Use this feature to display the elapsed time of your most recent call.

1. **Follow the steps in** “Getting to Show Call Timers...” to get to Show Last Call, and then press  to select.

You will see the airtime of the most recent call in hours, minutes, and seconds. After several seconds, the display returns to Show Last Call.

2. **Press and hold**  to exit the menu.





Note: The last call timer shows elapsed time of the most recent call made since your phone was turned on. This information is not saved when you shut off the phone.

This feature is not available in cellular mode.

Satellite Mode

Cellular Mode

Getting to Show Call Timers...

1. Press  until you see Call Meters, and then press .
2. Press  to scroll to Show Call Timers, and then press .
3. Press  to scroll to one of the features described below.

Satellite Mode

Show Total Time for All Calls

Use this feature to display your total airtime since you last reset the Call Timer.

1. Follow the steps in “Getting to Show Call Timers...” to get to Total For All Calls, and then press  to select.

You will see the airtime accumulated since the timer was last reset. The airtime is displayed in hours, minutes, and seconds. After several seconds, the display returns to Total For All Calls.

2. Press and hold  to exit the menu.

Cellular Mode

This feature is not available in cellular mode.

Satellite Mode

Reset All Timers

Reset your timers at the beginning of each billing cycle to keep track of your spending.

1. Follow the steps in “Getting to Show Call Timers...” to get to Reset All Timers, and then press  to select.

You will see Completed. The display then returns to Reset All Timers.





2. Press and hold  to exit the menu.

Note: This does not reset the Lifetime Timer described on page 198.

Cellular Mode

This feature is not available in cellular mode.

Getting to Audible Call Timers...





1. Press  until you see Call Timers, and then press .
2. Press  to scroll to Set Audible Call Timers, and then press .
3. Press  to scroll to one of the features described below.

Setting Audible Call Timers

Let your phone watch the clock for you. The call timers signal at a set time or interval with beeps only you can hear.

Set the Single Alert Timer

Use this feature to set your phone to alert you after an elapsed time.

1. **Follow the steps in** “Getting to Audible Call Timers...” to get to Single Alert Timer, and then press  to select.
2. Press  to scroll to On or Off, and then press  to select.
 - If you select On, you will see Enter Seconds. Continue with **step 3**.
 - If you select Off, you will see Completed. Continue with **step 4**.
3. Press  to accept the current setting. You will see Seconds XXX.

or

Enter a number from 11 to 999, and then press . You will see Seconds XXX.





4. Press and hold  to exit the menu.

This feature is not available in cellular mode.

Satellite Mode

Cellular Mode





Getting to Audible Call Timers...

1. Press  until you see Call Meters, and then press .
2. Press  to scroll to Set Audible Call Timers, and then press .
3. Press  to scroll to one of the features described below.

Satellite Mode

Set the Repetitive Timer

Use this feature to set your phone to alert you at specific intervals, for example every 45 seconds.

1. Follow the steps in “Getting to Audible Call Timers...” to get to Repetitive Timer, and then press  to select.
2. Press  to scroll to On or Off, then press  to select.
 - If you select On, you will see Enter Seconds. Continue with **step 3**.
 - If you select Off, you will see Completed. Continue with **step 4**.
3. Press  to accept the current setting. You will see Seconds XXX.

or



Enter a number from 11 to 999, and then press . You will see Seconds XXX.

4. Press and hold  to exit the menu.

Cellular Mode





This feature is not available in cellular mode.

Getting to Call Meters...

1. Press  until you see Call Meters, and then press .
2. Press  to scroll to one of the features described below.

Showing the In-Call Timer

Use this feature to display a running clock of the airtime elapsed while on a call.



1. **Follow the steps in** “Getting to Call Meters...” to get to Set In-Call Display, and then press  to select.
2. Press  to scroll to Show Time Per Call or No In-Call Display, and then press  to select.
3. **Press and hold**  to exit the menu.

This feature is not available in cellular mode.

Satellite Mode

Cellular Mode

Getting to Call Meters...

1. Press  until you see Call Meters, and then press .
2. Press  to scroll to one of the features described below.

Showing the Lifetime Timer

Satellite Mode

Use this feature to show the total time of all calls for the life of your phone.

Note: This feature is available only when the extended menus are activated. See “Activating Extended Menus” on page 161.

1. **Follow the steps in** “Getting to Call Meters...” to get to Lifetime Timer, and then press  to select.

You will see the total airtime of your phone since it was manufactured.

2. **Press and hold**  to exit the menu.

Tip: *The lifetime timer can not be reset. The Reset All Timers feature has no effect on this timer.*

Cellular Mode

This feature is not available in cellular mode.

Customizing the Menu System

This chapter shows you several ways to customize the menu system to suit your personal needs. You can hide the menu features you don't use regularly, and you can add your favorite features to the Quick Access menu for instant recall.

Personalizing the Options Menu







You can customize the Options menu by moving features in and out of the extended menus. Features that you place on the extended menu are hidden when extended menus are turned off, and become visible when you activate the extended menus.

Note: The default factory setting for your phone is extended menus activated.

Move Menu Features

To move menu features:







1. **Find the feature** you want to move.
2. **Press and hold** . You will see one of two responses depending on where that menu feature is currently located. If you see:

Message	Description
Remove From Short Menu (The feature is in the short menu).	Press  to move the feature to the extended menu. You will see Menu Item Moved. or Press  to scroll to Leave in Short Menu, and then press  to select. You will see Move Cancelled.
Add To Short Menu (The feature is in the extended menu).	Press  to move the feature to the short menu. You will see Menu Item Moved. or Press  to scroll to Leave in Long Menu, and then press  to select. You will see Move Cancelled.

Note: Some features and submenus cannot be moved. You will see Cannot Move Menu Item.

Activate/Deactivate Extended Menus

Use the Options menu to activate and deactivate extended menus. Activate them when you need access to every feature. Deactivate them for everyday use.

1. **Press**  until you see Phone Setup, and then **press**  to select.
2. **Press**  to scroll to Extended Menus, and then **press**  to select.
3. **Press**  to scroll to either On or Off, and then **press**  to select.

All hidden features are accessible when you activate the extended menus.

Access Hidden Features









If you want to access a feature hidden in the extended menus, but don't want to leave the extended menus active, you can use this shortcut:

Press and hold  for a few seconds.





All extended menu features remain accessible until you exit the Options menu.

Personalizing the Quick Access Menu

You can replace the default Quick Access menu features described on page 71 with any of the following features.

Icon	Quick Access Feature
	Find by Location recalls a phone book entry by its memory location number.
	Add Entry to Phone stores entered numbers in the next available phone memory location.
	Add Entry to SIM stores entered numbers in the next available SIM card location.
	Ring Volume displays and sets the incoming call ring tone volume.
	Check Signal checks the strength of the signal from the satellite network.
	Switch Memory switches one-touch dialing between the phone and SIM memories depending on the current setting.
	Last Call Timer displays the duration of your last call.
	Show Services displays a list of service phone numbers programmed by your service provider.
	Mode Selection lets you switch between satellite and cellular service when you have an optional Cellular Cassette installed.

To change a default quick access feature to one of the features listed above:

1. Press  and then press  to scroll to the feature you wish to change.
2. Press and hold  to access the list of features available.
3. Press  to scroll through the list until you find the desired feature.
4. Press  to store the displayed feature in the new location. You will see **Completed**.









Troubleshooting

This chapter tells you what to do if you experience one of the following problems:

Problem	Solution
You can't turn the phone's power on.	<ul style="list-style-type: none">• Did you press and hold the Ⓞ key for three seconds to turn the phone's power on?• Check the battery. Is it charged, properly fitted, and are the contacts clean and dry?
You can't make calls.	<ul style="list-style-type: none">• Check the antenna. Is it fully extended and rotated? Do you have a clear unobstructed view of the sky?• Did you enter the number in international format? All calls made from the Iridium satellite system must be in international format (in satellite mode only).• Check the signal strength indicator. If the signal is weak, move to an open space or, if you are in a building, move closer to a window.• Check the Network Selection settings. Try to register manually in satellite mode. In GSM cellular mode, try a manual search and select another network.• Check your operator coverage map.• Is Restricted displayed? Check the call barring setting.• Has a new SIM card been inserted? Check that no new restrictions have been imposed.• Check to see if your fixed dialing list is enabled. If so, you can only make calls to numbers or prefixes that are on the list. To make calls in cellular mode, you must disable this feature from satellite mode.

Problem	Solution
<p>You can't receive calls.</p>	<ul style="list-style-type: none"> • Check to see that your phone is powered on. • Check the antenna. Is it fully extended and rotated? Do you have a clear unobstructed view of the sky? • Check the signal strength indicator. If the signal is weak, move to an open space or, if you are in a building, move closer to a window. • Check the call forwarding and call barring settings. • Check the ringer setting. If it is off, there is no audible ringer. • Check to see if your fixed dialing list is enabled. To receive calls in cellular mode, you must disable this feature from satellite mode.
<p>You can't make international calls.</p>	<ul style="list-style-type: none"> • Have you included the relevant codes? Press and hold the 0+ key to display the international dialing prefix (†) and then enter the appropriate country code followed by the phone number. • If you are in cellular mode, some service providers automatically bar the ability to make international calls. Contact your service provider. • Are you in a CDMA/AMPS cellular mode? You must map the international access code in order to use the 0+ key to display the international dialing prefix (+).
<p>Your phone will not unlock.</p>	<ul style="list-style-type: none"> • Have you inserted a new SIM card? Enter the new PIN code. • Do you have a replacement phone? Enter the default phone unlock code —1234. • Have you forgotten the unlock code? Press MENU to change the unlock code (you need your security code).
<p>Your PIN is blocked.</p>	<p>Enter the PIN unblocking key (PUK1) or contact your service provider. See “Unblock the PIN Code” on page 158 for additional information.</p>
<p>Your PIN2 is blocked.</p>	<p>Enter the PIN2 unblocking key (PUK2) or contact your service provider. See “Unblock the PIN2 Code” on page 160 for additional information.</p>
<p>Your SIM card will not work.</p>	<ul style="list-style-type: none"> • Is the card inserted the correct way? • Is the card visibly damaged or scratched? Return the card to your service provider. • Check the SIM and phone contacts. If they are dirty, clean them with an antistatic cloth.

Problem	Solution
<p>You can't access your messages.</p>	<ul style="list-style-type: none"> • Are you in the correct mode? If you do not have a GSM cellular cassette installed, you must be in satellite mode to access your messages. • Is your GSM Cellular Cassette inserted? In order to access messages from cellular mode, you must have a GSM Cellular Cassette inserted.
<p>You can't cancel call forwarding or call barring.</p>	<p>Wait until you are in an area with good network coverage and try again.</p>
<p>The  (message) indicator is flashing.</p>	<p>There is not enough memory available to store another message. Use the Messages menu to delete one or more messages.</p>
<p>The battery won't charge.</p>	<ul style="list-style-type: none"> • Check the charger. Is it properly connected? Are its contacts clean and dry? • Check the battery contacts. Are they clean and dry? • Check the battery temperature. If it is warm, let it cool before recharging. • Is it an old battery? Battery performance declines after several years of use. Replace the battery. • Make sure you have a Motorola approved battery installed. If you see <i>Invalid Batt.</i> in the display, you will not be able to charge this battery.
<p>The battery drains faster than normal.</p>	<ul style="list-style-type: none"> • Are you in an area of variable coverage? This uses extra battery power. • Is your antenna fully rotated and extended? Do you have a clear unobstructed view of the sky? This helps use less battery power. • Is it a new battery? A new battery needs two to three charge/discharge cycles to attain normal performance. • Is it an old battery? Battery performance declines after several years of use. Replace the battery. • Is it a battery that hasn't been completely discharged? Allow the battery to fully discharge (until the phone turns itself off) and then charge the battery overnight. • Are you using your phone in extreme temperatures? At extreme hot or cold temperatures, battery performance is significantly reduced.
<p>You find your phone becoming warm during use.</p>	<p>You may notice this during long calls or during charging. The heat is produced by the electronic components within your phone and is quite normal.</p>

Problem	Solution
<p>Your SIM card is inserted in the phone but the display says:</p>	<ul style="list-style-type: none"> • Check Card or Insert Card. Check that the SIM card has been inserted correctly. The contacts of the SIM card may be dirty. Turn the phone off, remove the SIM card and rub the contacts with a clean cloth. Replace the card in the phone. • Blocked or  Blocked Enter the PIN unblocking key (PUK1) or the PIN2 unblocking key (PUK2) respectively, or contact your service provider. See “Unblock the PIN Code” on page 158 and “Unblock the PIN2 Code” on page 160 for additional information. • Bad Card See Supplier. Please contact your service provider.
<p>Your phone has a Cellular Cassette installed but the display says:</p>	<p>Check Cassette or Insert Cassette. Check that the Cellular Cassette has been inserted correctly.</p>
<p>You do not have a Cellular Cassette and your phone says Insert Cassette.</p>	<p>Make sure you have the correct mode settings selected. You are either in Cellular Always mode or in a Preferred mode.</p>
<p>You find your phone's prompts in a language other than your own.</p>	<ol style="list-style-type: none"> 1. Press and hold the  key to return to the idle display. 2. Press     to go directly to the language selection submenu. 3. Press  until you see your preferred language. 4. Press  to select.

Index

Symbols

- * character 48
- + character 47, 48
- ▣ character 48, 84

A

- AC travel charger 20
- accessories 19–23
- accessory connector
 - defined 15
 - illustration 13
- Activated message 156
- Activating Cancel? 156
- adapter
 - antenna 22
 - auto accessory 21
- Add To Short Menus message 200
- airbag 10
- alert, incoming call 52
- alphanumeric keypad 13
- antenna
 - adapter 22
 - attaching 26
 - care 7
 - Cellular Cassette antenna 13
 - clear-line-of-sight 14
 - detents 14, 44
 - extending 44
 - illustration 44
 - lock release button 13, 15, 26
 - removing 26
 - rotating 44
- audible call timers
 - repetitive 196
 - resetting default settings 169
 - single alert 195
- auto accessory adapter 21, 35–36

- automatic lock
 - resetting default 169
 - setting 154
- automatic redial 48

B

- Bad Card See Supplier message
 - 44, 206
- barring calls
 - incoming 119
 - outgoing 118
- battery
 - cautions 8, 38
 - charge indicator
 - defined 17
 - displayed 35, 37
 - illustration 13
 - charge meter 71, 122
 - charging 35–36
 - Charging Battery message 35, 122
 - compartment illustration 33
 - desktop charger 36
 - disposal 38
 - Fast Charge Completed message
 - 122
 - installing 31–32
 - internal charger 35–36
 - Invalid Batt. message 31, 122
 - Low Battery message 37
 - Not Available message 122
 - power level, checking 122
 - removing 33–34
 - safety cover 30
 - standby time 19
 - talk time 19
 - troubleshooting 205
- Blocked message 44, 158, 206

- !** Blocked message 44, 160, 206
- Busy Try Later message 47, 59, 62, 69, 179

C

call

- answering 51–52
 - automatic redial 48
 - barring 117–121
 - conference call 63–65
 - dialing special characters 48
 - emergency call 49
 - ending 50, 53
 - forwarding 108–115
 - holding 61–65
 - incoming call alert 52
 - international call 47
 - last ten calls 97–98
 - muting 58
 - placing 46–50
 - receiving 51–53
 - redialing last number 48
 - returning a call 135
 - unable to make call 203
 - unable to make international call 204
 - unable to receive call 204
- Call Answer? 51, 52
- call barring
 - barr password
 - changing 121
 - entering 118–121
 - cancelling 120
 - incoming calls 119
 - outgoing calls 118
 - unable to cancel 205
- Call Failed message 51, 52
- call forwarding
 - all calls 110–111
 - cancelling 115
 - from Quick Access menu 71
 - unable to cancel 205

- call forwarding (continued)
 - voice calls 112–114
 - when unavailable 108
- call holding

- CDMA cellular mode 62
- conference call 63, 65
- ending 61–62
- making new call 61
- messages 62
- placing call on hold 61
- switching between calls 61
- TDMA cellular mode 62

Call Meters menu

- diagram 192
- Lifetime Timer feature 198
- Repetitive Timer feature 196
- Reset All Timers feature 194
- Set Audible Call Timers feature 195–196
- Show Call Timers feature 193–194
- Show In-Call Display feature 197
- Show Last Call feature 193
- Single Alert Timer feature 195
- Total For All Calls feature 194

call meters. *See* call timers

Call Related Features menu

- Call Barring feature 117–121
 - Bar Incoming Calls 119
 - Bar Outgoing Calls 118
 - Cancel All Barring 120
 - Change Bar Password 121
- Call Forwarding feature 108–115
 - Cancel All Forwarding 115
 - Detailed Forwarding 112–114
 - Forward All Calls 110–111
 - Forward When Unavailable 108

- Call Waiting feature 116
- diagram 106–107
- Pending Call Drop feature 124

- Call Related Features menu
 - (continued)
 - Restrict My Phone Number
 - feature 125
 - Show Battery Meter feature 122
 - Show Signal Strength feature 123
- call timers
 - all calls 194
 - elapsed airtime 197
 - in-call timer 197
 - lifetime timer 198
 - most recent call 193, 202
 - repetitive 196
 - resetting all 170, 194
 - single alert 195
 - total airtime 194
- call waiting
 - accepting waiting call 59
 - activating 116
 - CDMA cellular mode 60
 - ending current call 59
 - messages 59
 - rejecting waiting call 59
 - TDMA cellular mode 60
- Call Waiting Answer? 59
- Call? 46
- callback number 135
- Calling message 46
- Cannot Hold Second Call message 59, 62
- Cannot Move Menu Item message 200
- carry case 22
- Cassette Removed message 40
- cellular always mode
 - defined 187
 - phone behavior 187
 - selecting 190
- Cellular Cassette
 - antenna 13
 - Cassette Removed message 40
- Cellular Cassette (continued)
 - cellular network access with 185
 - Check Cassette message 206
 - connector 13, 15
 - defined 23
 - Insert Cassette message 206
 - inserting 39
 - removing 40
 - troubleshooting 206
- cellular mode
 - active phone number,
 - changing 175
 - muting a call 58
 - restricting phone number ID 125
 - selecting 190, 202
 - system scan settings 174
- cellular preferred mode
 - defined 187
 - phone behavior 187
 - selecting 190
- charger, AC travel 20
- Charging Battery message 35, 122
- Check Card message 43, 206
- Check Cassette message 188, 190, 206
- check mark indicator
 - defined 18
 - displayed 175
- Check Signal message 43, 179
- Checking Signal... message 123
- clear key, defined 14
- clearing stored information 170
- clear-line-of-sight, defined 14
- clock
 - changing time display 163
 - defined 17
 - illustration 13
 - setting 164
 - setting format 163

- code
 - phone unlock 154–155
 - security 91, 155, 160, 169, 170
 - SIM card PIN 43, 157–158
 - SIM card PIN2 92–95, 159–160

- Completed message 69

- conference call
 - adding single call 63, 65
 - beginning 63, 65
 - CDMA cellular mode 65
 - ending 64
 - ending all active calls 65
 - ending all held calls 65
 - holding a private conversation 64, 65

- keypad controls 65
- making new call 63
- messages 64
- placing call on hold 63, 65
- releasing single call 65
- TDMA cellular mode 65

- Conference Full message 64

- Conference Unsuccessful message 64

- Connected message 46, 51, 52

- Connection Lost message 156

D

- date

- setting 164
 - viewing 162

- default settings, resetting 169

- desktop charger 36

- detents, antenna 14, 44

- dialing

- ☎ 48

- * character 48

- † character 48

- ▣ character 48, 84

- international call 47

- last ten calls 97–98
 - number with pauses 85

- phone book entry 89

- dialing (continued)

- phone number 46

- special characters 48

- supplementary service numbers 48

- display

- backlighting 166

- cold temperatures and 15

- illustration 13

- indicators and icons 13, 17–18

- language, selecting 165

- special characters 48

- standby mode 45

- wrong language displayed 206

E

- earpiece

- adjusting volume 54

- illustration 13

- elapsed airtime timer 197

- emergency call 49

- Emergency Calling message 49

- emergency number 171

- End Call? 46, 50, 53

- Enter Name message 69

- Enter Phone Unlock Code message 43, 155

- Enter PIN message 43, 69, 157

- Enter PIN2 message 92–95

- exiting menus and menu features 68

- extended menus

- activating 161, 201

- Call Barring 117

- deactivating 161, 201

- default setting 200

- defined 200

- Detailed Call Forwarding 112

- Language Selection 165

- Lifetime Timer 198

- Lights 166

- moving menu features 200

- Select Keypad Tones 167

extended menus (continued)
Set Time and Date 164
Set Time Format 163
Show Time and Date 162, 163
external devices, communicating
with 156

F

Failed message 69
Fast Charge Completed message
122
fixed dial list
defined 92
entry
adding 93
editing 95
erasing 94
one-touch dialing 101
viewing 96
fixed dialing
activating 92
PIN2 code 159
viewing fixed dial list 96
Flash Options message 66, 74
forwarding calls
all calls 110–111
cancelling 115
from Quick Access menu 71
voice calls 112–114
when unavailable 108

G

GSM cellular network
find new network 183
registering 180
scanning 180
search method 181–182
GSM SIM card 27

H

headset 21
headset jack 13, 15, 21
Hold Failed message 59, 62

holding a call
CDMA cellular mode 62
conference call 63, 65
ending 61–62
making new call 61
messages 62
placing call on hold 61
switching between calls 61
TDMA cellular mode 62
home system indicator
defined 18
displayed 42, 179, 180
hourglass indicator
defined 18
displayed 69

I

icons
display 13, 17–18
Quick Access menu 18, 71,
202
in use indicator 18
In-Call menu
call holding 61–65
call waiting 59–60
CDMA cellular mode 74
conference call 63–65
defined 72
entering 72
menu features 72–74
muting a call 58
TDMA cellular mode 74
in-call timer
defined 197
resetting 169
incoming call alert 52
indicators
battery charge 13, 17, 35, 37
check mark 18, 175
display 13, 17–18
home system 18, 42, 179, 180
hourglass 18, 69
in use 18
message 17, 130, 139, 205

- indicators (continued)
 - no service 18, 42
 - real time clock 17
 - roam 18, 180
 - satellite mode 17, 188, 189, 190
 - scroll bar 18, 69
 - signal strength 13, 17, 123, 179
 - status 13, 16
- infrared data port
 - activating 156
 - deactivating 156
 - defined 15
 - illustration 13
- Insert Card message 43, 206
- Insert Cassette message 188, 190, 206
- international call
 - dialing + character 48
 - placing 47
 - unable to make 204
- international dialing prefix
 - default 172
 - dialing 47
 - resetting default setting 169
 - setting 172
- Invalid Account message 43
- Invalid Batt. message 31, 122
- IrDA port. *See* infrared data port
- Iridium Call Attempt message 52

K

- key presses 12
- keypad
 - keypad tones, setting 167
 - locking 54
 - resetting default tones 169
 - unlocking 54
- keys
 - alphanumeric keypad 13
 - clear 14
 - keypad tones, setting 167
 - locking the keypad 54

- keys (continued)
 - memory recall 14, 55, 88, 99
 - memory store 14, 81, 97, 98
 - menu 14
 - menu system, navigating 68
 - message 13, 14, 129–147
 - OK 14
 - power 13, 14, 42
 - quick access 13, 14, 55, 70, 152
 - scroll 14
 - unlocking the keypad 54
 - volume control 13, 14, 54, 55, 152

L

- language
 - selecting 165
 - wrong language displayed 206
- last call timer
 - defined 193
 - displaying 193, 202
- last ten calls
 - clearing 170
 - placing a call 97–98
- LCD. *See* Liquid Crystal Display
- Leave in Long Menus message 200
- Leave in Short Menus message 200
- lifetime timer 198
- Liquid Crystal Display
 - cold temperatures and 15
 - indicators and icons 17–18
- locking the keypad 54
- locking the phone
 - automatically 154
 - from Quick Access menu 71
 - instantly 154
 - See also* unlocking the phone
- Low Battery message 37

M

- making a call 46–50
- master clear 170
- master reset 169
- memory
 - phone 78, 80, 81
 - SIM card 78, 80, 81
- memory recall key 14, 55, 88, 99
- memory store key 14, 81, 97, 98
- menu
 - Add To Short Menus message 200
 - Call Meters 191–198
 - Call Related Features 105–125
 - Cannot Move Menu Item message 200
 - customizing 199–202
 - defined 67
 - exiting 68
 - feature selection messages 69
 - indicators 69
 - Leave in Long Menus message 200
 - Leave in Short Menus message 200
 - Menu Item Moved message 200
 - Messages 127–147
 - Mode Selection 185–190
 - Move Cancelled message 200
 - Network Selection 177–183
 - Phone Book 75–103
 - Phone Setup 149–175
 - questions 69
 - Remove From Short Menus message 200
 - scrolling 68, 70
 - using 67–74
- Menu Item Moved message 200
- menu key 14
- message editor 136–139
- Message Failed Resend? 139, 142
- message indicator
 - defined 17
 - displayed 130
 - flashing 17, 130, 139, 205
- message key
 - defined 14
 - illustration 13
 - using 129–147
- Message Read Now? 130, 132
- Message Sent message 139, 142
- messages
 - callback number 135
 - contents 131
 - creating 137
 - deleting 134, 143
 - editing 138
 - feature selection indications 69
 - go to next message 134, 141
 - message key 129–147
 - notification
 - incoming voicemail 132
 - received message(s) 130
 - phone 12
 - reading
 - from Quick Access menu 71
 - incoming 132
 - stored 133
 - received 53, 132–135
 - returning a call 135
 - sending 136–143
 - unable to access messages 205
 - voicemail 132
- Messages menu
 - Call Voicemail feature 129
 - diagram 128
 - Message Editor feature 136–139
 - Message Settings feature 144–147
 - Outgoing Messages feature 140–143

- Messages menu (continued)
 - Received Messages feature 133–135
 - Voicemail Number feature 144
- microphone 13
- Mode Selection menu
 - cellular always mode 190
 - cellular preferred mode 190
 - diagram 186
 - satellite always mode 189
 - satellite preferred mode 188
- mode, selecting 188–190, 202
- Move Cancelled message 200
- multiple-key answer 51, 52
- Mute End Call? 58
- muting a call 58, 71

N

- network
 - GSM cellular
 - find new network 183
 - registering 180
 - scanning 180
 - search method 181–182
 - satellite, registering 71, 179
- network features
 - call barring 117–121
 - call forwarding 108–115
 - call holding 61–65
 - call waiting 59–60, 116
 - conference call 63–65
- Network Selection menu
 - Available Networks feature 180
 - diagram 178
 - Find New Network feature 183
 - Network Search feature 181–182
 - Register Now feature 179
- No Number Available message 129
- No Service Center message 139, 142

- no service indicator
 - defined 18
 - displayed 42
- Not Available message 122

O

- OK key 14
- one-touch dialing
 - frequently called numbers 78
 - switching memory, from Quick Access menu 202
 - using 101–102
- Options menu
 - customizing 200–201
 - defined 67
 - entering 68
 - exiting 68
 - using 68–69
- Orient Antenna Call Attempt message 51, 52
- Overwrite? 81

P

- password, call barring 118–121
- pause dialing 48, 84–85
- pauses in numbers, entering 84
- Pending Call Drop message 124
- pending call drop signal 124
- Personal Identification Number code 157
 - See also* PIN code
- personal mailbox 53, 131
- phone
 - becomes warm during use 205
 - emergency number 171
 - features, customizing 149–175
 - holding 44
 - illustration 13
 - locking
 - automatically 154
 - from Quick Access menu 71
 - instantly 154
 - messages at power-on 43

- phone (continued)
 - security code, default 155
 - service phone numbers 103, 202
 - settings
 - clearing 170
 - resetting default 169
 - viewing 168
 - turning on and off 42
 - unable to make call 203
 - unable to make international call 204
 - unable to receive call 204
 - unable to turn on 203
 - unable to unlock 204
 - unblocking the PIN code 158
 - unblocking the PIN2 code 160
 - unlock code
 - changing 155
 - default 154
 - entering 154
 - unlocking 154
 - use while driving 8
 - use with other electronic devices 9–10
- phone book
 - adding an entry 80–83
 - capacity, checking 90
 - characters, entering 82–83
 - entries
 - clearing all 170
 - scrolling through 54, 87
 - entry
 - adding 80–83, 202
 - calling 89
 - changing 86
 - correcting 82
 - erasing 89
 - locating 87–88
 - modifying 89
 - find entry by location 88, 202
 - find entry by name 71, 87
- phone book (continued)
 - fixed dial list
 - adding an entry 93
 - editing an entry 95
 - erasing an entry 94
 - fixed dialing
 - activating 92
 - viewing fixed dial list 96
 - last ten calls 97–98
 - memory recall key 88
 - memory store key 81
 - menu diagram 76–77
 - name
 - entering 82–83
 - storing 80–81
 - number
 - calling 89
 - entering 80–81
 - storing 80–81
 - one-touch dialing 101–102
 - organizing 78
 - pauses in numbers
 - dialing 85
 - entering 84
 - phone memory 78
 - phone numbers
 - grouping 79
 - security issues 79
 - storing 78
 - prefixes, using 86
 - preventing access 91
 - Restricted message 91
 - SIM card memory 78
 - storage capacities 78
- Phone Book menu
 - Add Entry feature 80–83
 - Call Number feature 89
 - Check Capacity feature 90
 - diagram 76–77
 - Erase Name And Number feature 89
 - Find Entry By Location feature 88
 - Find Entry By Name feature 87

- Phone Book menu (continued)
 - Modify Name Or Number feature 89
 - My Phone Number(s) feature 99–100
 - One-Touch Dial Setting feature 101–102
 - Prevent Access feature 91
 - Setup Fixed Dialing feature
 - activating 92
 - Add Entry 93
 - Edit Entry 95
 - Erase Entry 94
 - Last Ten Calls 97–98
 - View Fixed Dial List 96
 - Show Services feature 103
- phone flash 66
- phone memory
 - checking capacity 90
 - entries, clearing all 170
 - one-touch dialing 101
 - storage capacities 78
- phone number
 - active number, changing 175
 - dialing 46
 - modifying on SIM card 100
 - programming on SIM card 100
 - restricting ID with outgoing calls 125
 - using pauses in 84
 - using prefixes 86
 - viewing your own 99
- phone settings
 - clearing 170
 - resetting default 169
 - viewing 168
- Phone Setup menu
 - Activate IR Port feature 156
 - Adjust Ring Volume feature 152
 - Automatic Lock feature 154
 - Change Clock feature 163
 - Change Number feature 175
- Phone Setup menu (continued)
 - Change SIM Card PIN feature 158
 - Change SIM Card PIN2 feature 159
 - Change Unlock Code feature 155
 - diagram 150–151
 - Emergency Mapping feature 171
 - Extended Menus feature 161, 201
 - International Dialing Prefix feature 172
 - Language Selection feature 165
 - Lock Now feature 154
 - Master Clear feature 170
 - Master Reset feature 169
 - New Security Code feature 160
 - Phone Lock feature 154–155
 - Phone Status feature 168–170
 - Require SIM Card PIN feature 157–158
 - Ring or Vibrate feature 153
 - Select Keypad Tones feature 167
 - Set Ringer Tone feature 153
 - Set Time and Date feature 164
 - Set Time Format feature 163
 - Show Time and Date feature 162
 - Status Review feature 168
 - System Scan feature 173–174
- phone unlock code
 - changing 155
 - default 154
 - entering 154
- PIN code
 - activating 157
 - Blocked message 44, 158, 206
 - changing 158
 - deactivating 157

PIN code (continued)
 defined 157
 Enter PIN message 43, 157
 entering 43, 157–158
 incorrect entry 158
 unblocking 158
PIN unblocking key (PUK1)
 defined 158
 entering 158
PIN2 code
 ! Blocked message 44, 160,
 206
 changing 159
 defined 159
 Enter PIN2 message 92–95
 entering 92–95
 incorrect entry 160
 unblocking 160
PIN2 unblocking key (PUK2)
 defined 160
 entering 160
placing a call 46–50
Please Try Later message 47,
 179
postscriping 86
power
 checking power level 122
 power-on messages 43
 turning phone on and off 42
 unable to turn on phone 203
power connector
 defined 15
 illustration 13
 using 35–36
power key
 defined 14
 illustration 13
 using 28, 35, 36, 42
prefixes 86
prompts, defined 12
PUK1. See PIN unblocking key
PUK2. See PIN2 unblocking key

Q

quick access key
 defined 14
 illustration 13
 ringer volume, adjusting 55,
 152
 using 70
Quick Access menu
 customizing 202
 default settings 71
 defined 70
 icons 18, 71, 202
 muting a call 58, 71
 quick access key 70
 replacing features 202
 using 70–71
Quit? 69

R

Range XXX-XX message 81
Reactivate IR Port message 156
real time clock
 changing time display 163
 defined 17
 illustration 13
 setting 164
 setting format 163
receiving a call 51–53
receiving messages 53
Reconnect Failed message 59, 62
redial
 automatic 48
 last number 48
Redial Failed message 48
Redial? 47, 48
Registered message 179
registering
 from Quick Access menu 71
 GSM cellular network 180
 satellite network 179
Registering... message 43, 46,
 179

- Remove From Short Menus message 200
- repetitive timer
 - defined 196
 - resetting default setting 169
 - setting 196
- Restricted Area message 47, 179
- Restricted message 91
- restricting calls 117–121
- restricting phone use 92–96
- restricting SIM card access 92
- ringer
 - activating 153
 - adjusting volume 55, 152, 202
 - deactivating 153
 - resetting default tone 169
 - setting tone 153
 - wakeup tone 42
- roam indicator
 - defined 18
 - displayed 180
- Rotate and Extend Antenna message 43, 47, 123, 179
- Rotate Antenna Call Attempt message 52
- Rotate Antenna Registering... message 43

S

- safety information 7–10
- satellite always mode
 - defined 187
 - phone behavior 187
 - selecting 189
- satellite antenna
 - illustration 44
 - lock release button 13, 15
- satellite mode
 - muting a call 58
 - selecting 188–189, 202
- satellite mode indicator
 - defined 17
 - displayed 188, 189, 190
- satellite network, registering 71, 179
- satellite preferred mode
 - defined 187
 - phone behavior 187
 - selecting 188
- scroll bar
 - defined 18
 - displayed 69
- scroll key 14
- scrolling 68, 70
- Searching... message 43
- security code
 - changing 160
 - default 91, 155, 160
 - defined 160
 - entering 91, 155, 160, 169, 170
- security features 157–160
- Select? 69
- Send Digits? 85
- Send Flash? 66
- service phone numbers 103, 202
- short menus 200
- SID. *See* System Identification number
- signal strength indicator
 - defined 17
 - illustration 13
 - satellite network registration and 179
 - viewing 123, 202
- SIM card
 - Bad Card *See* Supplier message 44, 206
 - Blocked message 44, 158, 206
 -  Blocked message 44, 160, 206
 - Check Card message 43, 206
 - defined 27
 - display messages 206
 - fixed dial list 92
 - GSM SIM card 27
 - Insert Card message 43, 206

- SIM card (continued)
 - inserting 28
 - phone number
 - entering 100
 - modifying 100
 - security issues 79
 - viewing your own 55, 99
 - PIN code
 - activating 157
 - changing 158
 - deactivating 157
 - defined 157
 - Enter PIN message 43, 157
 - entering 43, 157–158
 - incorrect entry 158
 - unblocking 158
 - PIN2 code
 - changing 159
 - defined 159
 - Enter PIN2 message 92–95
 - entering 92–95
 - incorrect entry 160
 - unblocking 160
 - precautions 27, 28
 - protecting 157–158
 - removing 28
 - restricting access 92
 - security features 157–160
 - storing messages
 - outgoing 139
 - received 132
 - troubleshooting 204, 206
 - SIM card memory
 - checking capacity 90
 - one-touch dialing 101
 - storage capacities 78
 - single alert timer
 - resetting default setting 169
 - setting 195
 - special characters 48
 - Split Call Unsuccessful message 64
 - standby mode 45
 - standby time, battery 19
 - status indicator
 - defined 16
 - illustration 13
 - Stored to Outgoing message 139
 - Stored XXX message 81
 - submenus, defined 67
 - supplementary service numbers 48
 - System Identification number
 - defined 174
 - shown in display 173
- T**
- talk time, battery 19
 - time
 - away time, defined 164
 - changing clock display 163
 - home time, defined 164
 - setting 164
 - setting format 163
 - viewing 162
 - timers
 - all calls 194
 - elapsed airtime 197
 - in-call timer 197
 - lifetime timer 198
 - most recent call 193, 202
 - repetitive 196
 - resetting all 194
 - single alert 195
 - total airtime 194
 - total airtime timer 194
 - travel charger 35–36
 - troubleshooting 203–206
 - Trying message 59, 62
- U**
- Unanswered Call message 53
 - unanswered calls 53
 - unblocking
 - SIM card PIN code 158
 - SIM card PIN2 code 160

- unlock code
 - changing 155
 - default 154
 - entering 154
- unlocking the keypad 54
- unlocking the phone 154
 - See also* locking the phone

V

- VibraCall alert function
 - activating 71, 153
 - deactivating 153
 - phone power-on and 42
- vibration mode. *See* VibraCall alert function
- View Options? 69
- voicemail
 - call forwarding when
 - unavailable 108
 - checking 71, 129
 - detailed call forwarding 112–114
 - forward all calls 110–111
 - No Number Available message 129
 - notification message 130, 132
 - storing voicemail number 144
- volume
 - control keys illustration 13
 - earpiece, adjusting 54
 - resetting default 169
 - ringer, adjusting 55, 152, 202
- volume level display 54

W

- wakeup screen 42
- wrist strap 23

Patent Information

Manufactured under one or more of the following U.S. patents:

4121218	4616314	4741034	D306594	5083304	D337332	D354062	D368696
4138681	4617520	4742562	4912602	D324024	5230007	5384825	5510693
4193036	D286778	D295627	4918732	D324388	5230093	D356084	5511235
4254382	4626309	4746242	4922178	5095503	5233633	5402447	D369162
4302845	4628529	D295973	4945570	D325028	5235492	5406146	5513078
4312074	4629829	D295975	4954796	D325583	5237257	5406562	D369359
4327319	4630304	4751737	4959851	5109536	5239127	D357224	5519303
4329666	4630305	D296187	4963812	D325915	5241545	D357457	5519346
4369516	4633141	4761621	4963843	5113436	5241548	5410741	5524276
4369522	4636593	4764737	4965537	5117450	5241650	D357680	5524278
4378603	4636741	D297734	4972355	5121047	5241693	D357681	D370463
4390963	D288432	D297735	4972432	5122480	5242767	5428836	5530922
D269873	4648125	4777564	4972455	5122722	D339582	D359734	5542116
4398265	4649543	Re.32768	4975808	D327061	5249302	D359735	5544250
4400584	D288683	D299136	4984290	5128834	5251331	D359959	D372481
4400585	4654655	4797929	D314173	D328302	D340710	5432017	5546275
D270835	D289156	4798975	D315330	5142551	5260988	D360632	5546380
D271491	4662691	4800348	D315346	5142696	5261119	5438684	D372896
Re.31470	4667333	4802236	D315543	5146620	5262710	D361070	5551078
4431977	4668917	4809356	D315559	5148471	5263052	5442680	5559471
4434461	4670747	4811377	D315565	5148473	5276707	5446763	D374424
4455534	4672502	4811404	5004992	5148961	5278994	5448763	D374872
4462098	4680787	4827226	D315907	5150359	D343173	5448771	5572193
D275951	4681476	4827507	5008925	5150384	5280637	5453997	5574976
4484153	4683585	4829274	D316417	5152006	D344087	D362840	5577268
4485486	4692726	4837534	D316859	5157693	5287553	5457744	D375732
4486624	4704588	D301476	5017856	5163159	5287555	5459640	D375733
D276809	D292578	4843621	5018188	5164652	5287556	5463646	D375734
4491972	4706036	4845772	5020091	5166596	D344511	5465412	D375932
D277667	D292920	D302015	5020092	5175759	5301365	5469177	D375952
4504834	4710724	4851966	5020093	5175874	5321847	5475752	D376127
D278708	4711361	4868576	5028083	D332261	D348880	D365094	5588041
4523155	4715063	4870686	5028859	5182749	5349588	D365817	5589796
4546329	4716319	D303656	5029044	D332785	5359696	5486843	5590177
4550426	4716391	4876552	5029233	5185566	5361400	5487184	5594778
4551696	4723305	4879533	5031028	5187809	5363071	5488335	5594951
4564821	D294257	D305427	5036532	5193223	5365549	5488649	D377792
D282169	4727306	4896124	5053924	5195106	D352497	D366872	D377934
4571595	4727583	4897873	5057762	5195108	5366826	5493198	5604050
4573017	4730195	D305717	D320780	5201069	D353131	5493714	5606730
4574243	4734635	4904549	5059885	5204977	D353361	5497126	D378366
4585957	4736277	4905288	5060294	5210793	5375143	5497382	5613229
4602218	4737976	4905301	D322783	5214675	5375258	D367640	5613863
D284759	4740794	D306293	D322955	5222104	5379324	5499394	5615233
D285439	4741018	D306441	5081674	5222251	D354055	5506490	5621763

Other patents pending.

In order to access Iridium LLC Global Customer Care
(24 hours a day, 7 days a week), dial one of the following numbers:

English:	811* or +8817-629-90051 or +407-659-1331
Spanish:	812* or +8817-629-90052 or +407-659-1332
Portuguese:	813* or +8817-629-90053 or +407-659-1333
Russian:	814* or +8817-629-90054 or +61-2-9215-1514
German:	815* or +8817-629-90055 or +61-2-9215-1515
Italian:	816* or +8817-629-90056 or +612-2-9215-1516
French:	817* or +8817-629-90057 or +61-2-9215-1517
Japanese:	818* or +8817-629-90058 or +61-2-9215-1518
Cantonese:	819* or +8817-629-90059 or +61-2-9215-1519
Mandarin:	820* or +8817-629-90060 or +61-2-9215-1520
Korean:	821* or +8817-629-90061 or +61-2-9215-1521
Thai:	822* or +8817-629-90062 or +61-2-9215-1522
Arabic:	823* or +8817-629-90063 or +612-2-9215-1523
Other:	824* or +8817-629-90064 or +61-2-9215-1524

TTY Toll-Free Number 1-888-390-6456

TTY (outside the United States) +1-847-523-1841

+ designates international dialing access code (00)



MOTOROLA

A satellite is shown in orbit around a globe. The globe is a light blue color with white grid lines, and the satellite is a small black object with solar panels. The orbit is a glowing blue ring. The word 'satellite' is written in a large, white, sans-serif font across the center of the orbit, and the word 'SERIES' is written in a smaller, white, sans-serif font below it. A small 'TM' trademark symbol is located to the right of the word 'SERIES'.

s a t e l l i t e
S E R I E S

PRODUCTS FOR
THE IRIDIUM SYSTEM

In order to contact Motorola (Monday thru Friday 7AM to 7PM [CST]),
dial one of the following numbers:
US & Canada: 1-888-839-4647
Outside the US & Canada: (Toll-Free Global Number): +1-8000-839-4647
Direct Dial: +1-847-523-1898

TTY Toll-Free Number 1-888-390-6456
TTY (outside the United States): +1-847-523-1841
+ designates international dialing access code (00)

www.motorolasatellite.com

©1999 Motorola, Inc.

All trademarks identified as such herein are trademarks of Motorola, Inc.
(R) Reg. U.S. Pat. & Tm. Off.
Iridium and Iridium logos are trademarks and/or service marks of Iridium LLC